

BILL TO:	Date:	SHIP VIA:	Page of
	Account #:	<input type="checkbox"/> Will Call	Job #:
	P.O. #:	<input type="checkbox"/> Delivery Service	
SHIP TO:	Ordered by:	<input type="checkbox"/> Ship	
	Sidemark:		
	Phone #:	Fax #:	

# HunterDouglas

## HERITANCE®

Hardwood Shutters

Opening #	Room	Qty.	Color ①	Hinge Color ②	Louver Size ③	IM or OM ④	Frame Type ⑤	Ordered Size ⑦		# of Panels Per Opening ⑧	Panel Configuration ⑨	Frame Detail ⑩	Buildout ⑪	Tilt Bar ⑫	Track Balance Type ⑬	Divider Rail Height (Double-Hung and Café Height) ⑭		T-Post ⑮				Magnets ⑯
								Width	Height							DR2	DR1	1st	2nd	3rd	4th	
														SP		DR2	DR1	1st	2nd	3rd	4th	
														SP		DR2	DR1	1st	2nd	3rd	4th	
														SP		DR2	DR1	1st	2nd	3rd	4th	
														SP		DR2	DR1	1st	2nd	3rd	4th	

NOTES: IM (Inside Mount) = Factory takes deductions. OM (Outside Mount) = Finished shutter size. See back order form key or Reference Guide for more details.

Everything below this dashed line is actual window opening dimensions and information. Above this dashed line is the order specification. Fabricators are only responsible for the information provided above this dashed line.

OPENING # \_\_\_\_\_ CLEARANCE DEPTH \_\_\_\_\_ TRIM TO TRIM

SILL DETAIL WINDOW DIAGONAL

A. Width \_\_\_\_\_ B. Height \_\_\_\_\_ C. Projection \_\_\_\_\_ D. \_\_\_\_\_ E. \_\_\_\_\_

← W

← W

← W                      H                      H                      H

↓                                      ↓                                      ↓

NOTES: **6** Rough Measure \_\_\_\_\_ X \_\_\_\_\_  
Number of Panels \_\_\_\_\_

SILL DETAIL AND WINDOW DIAGONAL MEASUREMENTS ARE DESCRIBED BELOW.

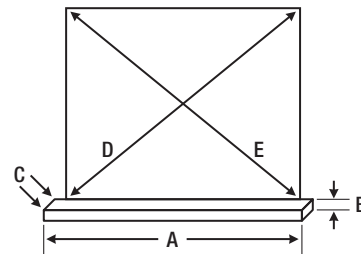

MEASURED BY (installer signature required)

INSTALLER CERTIFICATION NUMBER

CUSTOMER SIGNATURE (for verification)

DEALER SIGNATURE

DATE

OPENING # \_\_\_\_\_ CLEARANCE DEPTH \_\_\_\_\_ TRIM TO TRIM

SILL DETAIL WINDOW DIAGONAL

A. Width \_\_\_\_\_ B. Height \_\_\_\_\_ C. Projection \_\_\_\_\_ D. \_\_\_\_\_ E. \_\_\_\_\_

← W

← W

← W                      H                      H                      H

↓                                      ↓                                      ↓

NOTES: **6** Rough Measure \_\_\_\_\_ X \_\_\_\_\_  
Number of Panels \_\_\_\_\_

OPENING # \_\_\_\_\_ CLEARANCE DEPTH \_\_\_\_\_ TRIM TO TRIM

SILL DETAIL WINDOW DIAGONAL

A. Width \_\_\_\_\_ B. Height \_\_\_\_\_ C. Projection \_\_\_\_\_ D. \_\_\_\_\_ E. \_\_\_\_\_

← W

← W

← W                      H                      H                      H

↓                                      ↓                                      ↓

NOTES: **6** Rough Measure \_\_\_\_\_ X \_\_\_\_\_  
Number of Panels \_\_\_\_\_

# Heritage® Hardwood Shutters

## Order Form Key

Use the following key as a guide when completing the Heritage hardwood shutters order form.

**Note:** Items marked with an asterisk (\*) require a surcharge.

### 1 Color

Specify color number and name. Shown below are the five classic colors. See the product sampling for a complete list of colors.

701P = Bright White      708P = Eggshell      709P = Linen  
704S = Golden Oak      770S = Warm Cherry

### 2 Hinge Color

Specify hinge color number and name. Classic colors with which the hinge colors are standard are shown in parentheses.

009 = White (701P)      008 = Brushed Nickel Finish  
010 = Off-White (708P and 709P)      011 = Stainless Steel\*  
006 = Brass Finish      998 = Custom Painted Color\*  
007 = Antique Brass Finish (704S and 770S)  
022 = Ventian Bronze      023 = Satin Black

### 3 Louver Size

Specify louver size: 2 1/2", 3 1/2" or 4 1/2"

### 4 IM or OM

Specify inside mount or outside mount.

**IM** = Inside Mount

Factory takes a standard framed deduction of 1/4" from width and height or a standard without frame deduction of 3/16" from width and height.

On all inside mounts, diagonal measurements must be taken. If diagonal measurements are not equal, consider making greater deductions than the standard 1/4" (framed) or 3/16" (without frame). If the diagonal measurement difference is greater than 1/2", we recommend an outside mount for that particular window opening.

**OM** = Outside Mount

Factory takes no deductions. Submitted size will be the finished shutter size.

When measuring the opening of a typical window for outside mounts, we recommend adding the width of the base of the frame plus 1/4", per framed side, to the largest width and height measurements.

This provides a 1/4" reveal around the entire window opening.

Standard additions:

Frame Type	3-Sided Frame		4-Sided Frame	
	Width	Height	Width	Height
L1, BP, BF, BFB	3 1/4"	1 5/8"	3 1/4"	3 1/4"
L2	-	-	2 3/4"	2 3/4"

### 5 Frame Type (I) = Inside Mount, (O) = Outside Mount

The following types are priced as framed:

Z1 = Standard Z-frame (I)      Z2 = Deluxe Z-frame\* (I)  
Z3 = Colonial Z-frame (I)      Z4 = Tilt-In Z-frame (I)  
L1 = Standard L-frame (I or O)      L2 = Trim L-frame (I or O)  
BP = Bypass track system\*      BF = Bi-fold track system\*  
BPB = Bypass track system with bottom track\*  
BFB = Bi-fold track system with bottom track\*

(Factory takes 1/2" deduction for bottom track)

FD = French door (4-sided mitered HSB frame – OM only)

FDC = French door cut-out\* (OM only)

Z/L = Standard Z-frame and standard L-frame combination

AOS/[frame type] = Arch over shutter in a continuous opening

ART-T/[frame type] = Arch top panel – traditional\*

ART-S/[frame type] = Arch top panel – stepped\*

ANT/[frame type] = Angle top panel\*

The following types are priced as unframed:

HSS = Hang strip side-by-side      HSB = Hang strip behind

WF = Without frame (panels only)

WFBP = Bypass track system without frame\*

WFBF = Bi-fold track system without frame\*

WFBFB = Bi-fold track system without frame, with bottom track\*

WFBPB = Bypass track system without frame, with bottom track\*

**Note:** With the exception of French doors (FD), all HS frames are based on two hang strips, left and right. On inside mounts, two light stops top and bottom are included.

### 6 Rough Measure

Enter rough measurements and number of panels. This will be used as a guide for price estimates and configurations until a final measure is performed by a trained installer.

### 7 Ordered Size

Enter width and height dimensions to the nearest 1/16".

**Note:** Splices will occur on stained frames and valances over 91" and on painted frames and valances over 115".

### 8 Number of Panels Per Opening

1 = one panel      2 = two panels      3 = three panels, etc.

### 9 Panel Configuration

Print the letters of the panel configuration. Examples:

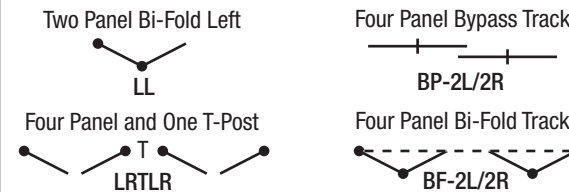

Then, in the appropriately numbered box, draw the panel configuration. Include the letters of the configuration.

**Note:** For windows requiring unequal panel widths, see reference guide for details.

### 10 Frame Detail

2 = 2-sided; 3 = 3-sided (top, left, right); 4 = 4-sided

4SIL = 3-sided L-frame or Z-frame with bottom sill frame†

2CAF = 2-sided Café style

3CAF = 3-sided Café style (left, right, bottom)

4CAF = 4-sided Café style, panels part way up\*

3CSIL = 2-sided Café style with bottom sill frame†

4CSIL = 3-sided Café style with bottom sill frame\*†

DH = Double-hung\* (specify 2, 3 or 4-sided: 2DH, 3DH or 4DH)

DHHT = Double-hung with horizontal T-post\* (specify 2, 3 or 4-sided: 2DHHT, 3DHHT or 4DHHT)

3D = 3-sided door which provides 5/8" floor clearance

SA = Special applications other than those listed above

† When using L-frame instead of bottom sill frame indicate with "-L".

**Note:** Indicate height for Café and Double-hung styles in column 14.

### 11 Build-Out

	FD, L2	L1, BP, BF
1 = Single build-out projection	1 3/8"	1 1/8"
2 = Double build-out projection	2 3/4"	2 1/4"
LS = Light stop (3/8" x 3/4")	3/8"	3/8"

### 12 Tilt Bar

F = Traditional front center tilt bar with upward closure

R = Rear tilt bar with upward closure\*

SP = Split tilt bar (enter height of split)

### 13 Valance Type (Track Systems Only)

S = Standard valance      D = Decorative valance\*

### 14 Divider Rail/Café/Double-Hung/Split Tilt Bar Height

DR1 = First divider rail (required for panel heights over 72")

DR2 = Second divider rail (required for panel heights over 102")

**Note:** Enter "C" if the desired location is at the center of the panel.

For OM (outside mount): Enter measurement(s) from bottom of frame to center of divider rail(s) or top of lower double-hung or café panel.

For IM (inside mount): Enter measurement(s) from inside bottom of window or sill to center of divider rail(s) or top of lower double-hung or café panel.

### 15 T-Post

EQ = T-post placed to provide equally divided openings

For unequal placement: Follow normal measuring guidelines. See Reference Guide for details.

### 16 Magnets

All 4-sided frames come standard with pre-installed magnets.

Y = Yes, pre-install      N = No, do not pre-install

### Lineal Materials

Grid prices include standard frames, T-posts and hardware. To order additional lineal materials, indicate quantity, color and length.

BILL TO:	Date:	SHIP VIA: <input type="checkbox"/> Will Call <input type="checkbox"/> Delivery Service <input type="checkbox"/> Ship	Page _____ of _____
	Account #:		Job #:
	P.O. #:		[Dashed Box]
SHIP TO:	Ordered by:		
	Sidemark:		
	Phone #:	Fax #:	

# HunterDouglas

## NEWSTYLE®

Hybrid Shutters

Opening #	Room	Qty.	Color ①	Hinge Color ②	Louver Size ③	IM or OM ④	Frame Type ⑤	Ordered Size ⑦		# of Panels Per Opening ⑧	Panel Configuration ⑨	Frame Detail ⑩	Buildout ⑪	Tilt Bar ⑫	Track Valance Type ⑬	Divider Rail Height (Double-Hung and Café Height) ⑭	T-Post ⑮				Magnets ⑯	
								Width	Height								1st	2nd	3rd	4th		
																DR2		1st	2nd	3rd	4th	
																DR1						
																DR2		1st	2nd	3rd	4th	
																DR1						
																DR2		1st	2nd	3rd	4th	
																DR1						

NOTES: IM (Inside Mount) = Factory takes deductions. OM (Outside Mount) = Finished shutter size. See order form key or reference guide for more details.  
 Everything below this dashed line is actual window opening dimensions and information. Above this dashed line is the order specification. Fabricators are only responsible for the information provided above this dashed line.

OPENING # \_\_\_\_\_ CLEARANCE DEPTH \_\_\_\_\_ TRIM TO TRIM

SILL DETAIL WINDOW DIAGONAL

A. Width \_\_\_\_\_ B. Height \_\_\_\_\_ C. Projection \_\_\_\_\_ D. \_\_\_\_\_ E. \_\_\_\_\_

← W

← W

← W                      H                      H                      H

↓                                      ↓                                      ↓

NOTES:  ⑥ Rough Measure \_\_\_\_\_ X \_\_\_\_\_  
Number of Panels \_\_\_\_\_

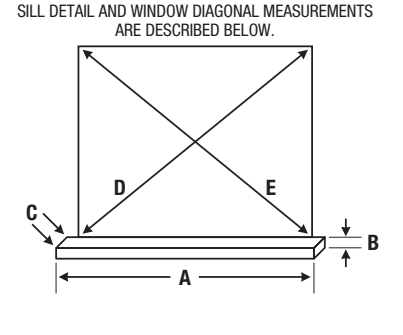

OPENING # \_\_\_\_\_ CLEARANCE DEPTH \_\_\_\_\_ TRIM TO TRIM

SILL DETAIL WINDOW DIAGONAL

A. Width \_\_\_\_\_ B. Height \_\_\_\_\_ C. Projection \_\_\_\_\_ D. \_\_\_\_\_ E. \_\_\_\_\_

← W

← W

← W                      H                      H                      H

↓                                      ↓                                      ↓

NOTES:  ⑥ Rough Measure \_\_\_\_\_ X \_\_\_\_\_  
Number of Panels \_\_\_\_\_

OPENING # \_\_\_\_\_ CLEARANCE DEPTH \_\_\_\_\_ TRIM TO TRIM

SILL DETAIL WINDOW DIAGONAL

A. Width \_\_\_\_\_ B. Height \_\_\_\_\_ C. Projection \_\_\_\_\_ D. \_\_\_\_\_ E. \_\_\_\_\_

← W

← W

← W                      H                      H                      H

↓                                      ↓                                      ↓

NOTES:  ⑥ Rough Measure \_\_\_\_\_ X \_\_\_\_\_  
Number of Panels \_\_\_\_\_

MEASURED BY (installer signature required) \_\_\_\_\_

INSTALLER CERTIFICATION NUMBER \_\_\_\_\_

CUSTOMER SIGNATURE (for verification) \_\_\_\_\_

DEALER SIGNATURE \_\_\_\_\_

DATE \_\_\_\_\_ / \_\_\_\_\_ / \_\_\_\_\_

OPENING # \_\_\_\_\_ CLEARANCE DEPTH \_\_\_\_\_ TRIM TO TRIM

SILL DETAIL WINDOW DIAGONAL

A. Width \_\_\_\_\_ B. Height \_\_\_\_\_ C. Projection \_\_\_\_\_ D. \_\_\_\_\_ E. \_\_\_\_\_

← W

← W

← W                      H                      H                      H

↓                                      ↓                                      ↓

NOTES:  ⑥ Rough Measure \_\_\_\_\_ X \_\_\_\_\_  
Number of Panels \_\_\_\_\_

# NewStyle® Hybrid Shutters

## Order Form Key

Use the following key as a guide when completing the NewStyle hybrid shutters order form.

Note: Items marked with an asterisk (\*) require a surcharge.

### 1 Color

Specify color number and name.

650 = Pure White      652 = Warm Cream      654 = Buttercup  
651 = Soft White      653 = Cameo White      655 = Gentle Taupe

### 2 Hinge Color

Specify hinge color number and name.

009 = White (standard with 650 Pure White)  
010 = Off-White (standard with 651 Soft White, 652 Warm Cream and 653 Cameo White)  
006 = Brass Finish  
007 = Antique Brass Finish  
008 = Brushed Nickel Finish  
011 = Stainless Steel\*  
012 = Buttercup (standard with 654 Buttercup)  
013 = Gentle Taupe (standard with 655 Gentle Taupe)  
022 = Venetian Bronze      023 = Satin Black

### 3 Louver Size

Specify louver size: 2 1/2", 3 1/2" or 4 1/2".

### 4 IM or OM

Specify inside mount or outside mount.

**IM** = Inside Mount

Factory takes a standard framed deduction of 1/4" from width and height or a standard without frame deduction of 3/16" from width and height.

On all inside mounts, diagonal measurements must be taken. If diagonal measurements are not equal, consider making greater deductions than the standard 1/4" (framed) or 3/16" (without frame). If the diagonal measurement difference is greater than 1/2", we recommend an outside mount for that particular window opening.

**OM** = Outside Mount

Factory takes no deductions. Submitted size will be the finished shutter size.

When measuring the opening of a typical window for outside mounts, we recommend adding the width of the base of the frame plus 1/4", per framed side, to the largest width and height measurements. This provides a 1/4" reveal around the entire window opening.

Standard additions:

Frame Type	3-Sided Frame		4-Sided Frame	
	Width	Height	Width	Height
L11	3 1/4"	1 5/8"	3 1/4"	3 1/4"
L12	-	-	2 3/4"	2 3/4"
C10	6"	3"	6"	6"
BP, BF, BFB	3 1/4"	1 5/8"	3 1/4"	3 1/4"

### 5 Frame Type (I) = Inside Mount, (O) = Outside Mount

The following types are priced as framed:

Z11 = Tilt-in Z-frame (I)  
Z12 = Colonial Z-frame (I)  
L11 = Standard L-frame (I or O)  
L12 = Trim L-Frame (I or O)  
C10 = Deluxe Casing frame (not available for ART or ANT). (O)  
BP = Bypass track system\*  
BF = Bi-fold track system\*  
FD = French door (4-sided mitered HSB frame – OM only)  
FDC = French door cut-out\* (OM only)  
Z/L = Colonial Z-frame and Standard L-frame combination  
AOS/[frame type] = Arch over shutter in a continuous opening  
ART-T/ [frame type] = Arch top panel - traditional\*  
ART-S/ [frame type] = Arch top panel - stepped\*  
ANT/ [frame type] = Angle top panel\*

The following types are priced as unframed:

HSS = Hang strip side-by-side      HSB = Hang strip behind  
WF = Without frame (panels only)  
WFBP = Bypass track system without frame\*  
WFBF = Bi-fold track system without frame\*

Note: With the exception of French doors (FD), all HS frames are based on two hang strips, left and right. On inside mounts, two light stops top and bottom are included.

### 6 Rough Measure

Enter rough measurements and number of panels. This will be used as a guide for price estimates and configurations until a final measure is performed by a trained installer.

### 7 Ordered Size

Enter width and height dimensions to the nearest 1/16".

Note: Splices will occur on frames and valances over 138".

### 8 Number of Panels Per Opening

1 = one panel      2 = two panels      3 = three panels, etc.

### 9 Panel Configuration

Print the letters of the panel configuration. Examples:

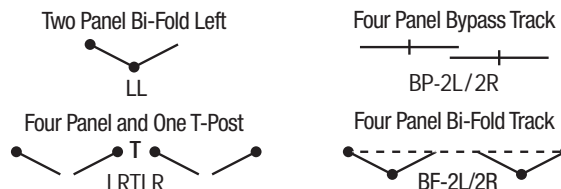

Then, in the appropriately numbered box, draw the panel configuration. Include the letters of the configuration.

Note: For windows requiring unequal panel widths, see reference guide for details.

### 10 Frame Detail

2 = 2-sided; 3 = 3-sided (top, left, right); 4 = 4-sided  
4SIL = 3-sided L-frame or Z-frame with bottom sill frame†  
2CAF = 2-sided Café style  
3CAF = 3-sided Café style (left, right, bottom)  
4CAF = 4-sided Café style, panels part way up\*  
3CSIL = 2-sided Café style with bottom sill frame†  
4CSIL = 3-sided Café style with bottom sill frame\*†  
DH = Double-hung\* (specify 2,3 or 4-sided: 2DH, 3DH or 4DH)  
DHHT = Double-hung with horizontal T-post\* (specify 2,3 or 4-sided: 2DHHT, 3DHHT, or 4DHHT)  
3D = 3-sided door which provides 5/8" floor clearance  
SA = Special applications other than those listed above  
† When using L-frame instead of bottom sill frame indicate with "-L".  
Note: Indicate height for Café and double-hung styles in column 14.

### 11 Build-out

	FD	L11, BP, BF
1 = Single buildout projection	1 3/8"	1 1/8"
2 = Double buildout projection	2 3/4"	2 1/4"
LS = Light stop (3/8" x 3/4")	3/8"	3/8"

### 12 Tilt Bar

F1 = Traditional front center tilt bar with upward closure only  
F2 = Traditional front center tilt bar with upward and downward closure  
R1 = Rear tilt bar with upward closure only\*  
R2 = Rear tilt bar with upward and downward closure\*  
SP = Split tilt bar (enter height of split)

### 13 Valance Type (Track Systems Only)

S = Standard valance

### 14 Divider Rail/Double Hung/Café Height

DR1 = First divider rail (required for panel heights over 72")  
DR2 = Second divider rail (required for panel heights over 102")

Note: Enter "C" if the desired location is at the center of the panel.

For OM (outside mount): Enter measurement(s) from bottom of frame to center of divider rail(s) or top of lower double hung or café panel.

For IM (inside mount): Enter measurement(s) from inside bottom of window or sill to center of divider rail(s) or top of lower double hung or café panel.

### 15 T-Post

EQ = T-post placed to provide equally divided openings

For unequal placement: Starting from the left, indicate distance in inches from left side of the shutter to center of each T-post.

### 16 Magnets

All 4-sided frames come standard with pre-installed magnets.  
Y = Yes, pre-install      N = No, do not pre-install

### Lineal Materials

Grid prices include standard frames, T-posts and hardware.  
To order additional lineal materials, indicate quantity, color and length.



# Palm Beach™ Polysatin Shutters

## Order Form Key

Use the following key as a guide when completing the Palm Beach polysatin shutters order form.

**Note:** Items marked with an asterisk (\*) require a surcharge.

### 1 Color

Specify color number.

051 = White Silk                      136 = Bright White  
137 = White                            138 = Linen

### 2 Hinge Color

Specify hinge color number. The standard hinge colors are standard are shown in parenthesis.

Lift Off Hinges with removable pin:

006 = Brass Finish                      007 = Antique Brass Finish  
008 = Brushed Nickel Finish        011 = Stainless Steel\*  
051 = White Silk (051 White Silk)    136 = Bright White (136 Bright White)  
137 = White (137 White)                138 = Linen (138 Linen)

Extended Leaf Hinge: Add -E. (Available in all colors.)

### 3 Louver Size

Specify louver size: 2 1/2", 3 1/2" or 4 1/2"

### 4 IM or OM

Specify inside mount or outside mount.

**IM** = Inside Mount

Factory takes a standard framed deduction of 1/4" from width and height or a standard without frame deduction of 3/16" from width and height.

On all inside mounts, diagonal measurements must be taken. If diagonal measurements are not equal, consider making greater deductions than the standard 1/4" (framed) or 3/16" (without frame). If the diagonal measurement difference is greater than 1/2", we recommend an outside mount for that particular window opening.

**OM** = Outside Mount

Factory takes no deductions. Submitted size will be the finished shutter size.

When measuring the opening of a typical window for outside mounts, we recommend adding the width of the base of the frame plus 1/4", per framed side, to the largest width and height measurements. This provides a 1/4" reveal around the entire window opening.

Standard additions:

Frame Type	3-Sided Frame		4-Sided Frame	
	Width	Height	Width	Height
S21, L21	3 1/8"	1 9/16"	3 1/8"	3 1/8"
C21	5 7/8"	2 15/16"	5 7/8"	5 7/8"
BP, BF	4 1/2"	2 1/4"	4 1/2"	4 1/2"

### 5 Frame Type (I) = Inside Mount, (O) = Outside Mount

The following types are priced as framed:

Z21 = Standard Z-frame (I)                      Z22 = Decorative Z-frame (I)  
Z23 = Colonial Z-frame (I)                      S22 = Decorative Z Sill (I or O)  
L21 = Standard L-frame (I or O)                C21 = Deluxe Casing frame (O)  
S21 = Deluxe Casing Sill (I or O)

Rubber Flex Option: Add -RF to frame options to specify Rubber Flex (Available on Z21, Z23 and L21 if inside mount)

Cover Strip Option: Add -CS to frame options to specify Cover Strip (Available on L21 and C21)

Example: For L21 with rubber flex and cover strip order L21-RFCS  
BP = Bypass track system\*                      BF = Bi-fold track system\*

BPBF = Bypass bottom floor guide\*  
BPBP = Bypass bottom panel guide\*

BFB = Bi-fold track system with bottom track\*  
(Factory takes 7/16" deduction for bottom track)

BO = Bypass Open\*                                BPUL = Bypass U/L Guide\*

FDC = French door cut-out\*

FDCWC = French door companion without cut-out

Available frame combinations: Z21/L21, Z23/L21, Z22/S22, and C21/S21. Must specify frame type and location in diagram.

The following types are priced as unframed:

HSS = Hang strip side-by-side                HSB = Hang strip behind  
WF = Without frame

WFBP = Bypass track system without frame\*

WFBF = Bi-fold track system without frame\*

WFBPB = Bypass track system without frame, with bottom track\*

WFBFB = Bi-fold track system without frame, with bottom track\*

### 6 Rough Measure

Enter rough measurements and number of panels. This will be used as a guide for price estimates and configurations until a final measure is performed by a trained installer.

### 7 Ordered Size

Enter width and height dimensions to the nearest 1/16".

**Note:** Splices will occur on frames and valances over 180".

### 8 Number of Panels Per Opening

1 = one panel    2 = two panels    3 = three panels etc.

### 9 Panel Configuration

Print the letters of the panel configuration. Examples:

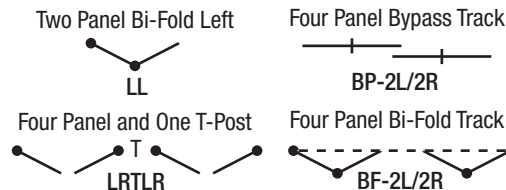

Then, in the appropriate opening box, draw the panel configuration. Include the letters of the configuration.

**Note:** For windows requiring unequal panel widths, see reference guide for details.

### 10 Frame Detail

2 = 2-sided; 3 = 3-sided (top, left, right); 4 = 4-sided  
4SIL = 4-sided with bottom sill    2CAF = 2-sided Café style (left, right)  
3CAF = 3-sided Café style (left, right, bottom)  
4CAF = 4-sided Café style, panels part way up\*  
3CSIL = 3-sided Café style with bottom sill  
4CSIL = 4-sided Café style with bottom sill, panels part way up\*  
DH = Double-hung\* (specify 2, 3 or 4-sided: 2DH, 3DH or 4DH)  
DHHT = Double-hung with horizontal T-post\* (specify 2, 3 or 4-sided: 2DHHT, 3DHHT or 4DHHT)

3D = 3-sided door which provides 5/8" floor clearance

SA = Special applications other than those listed above. Additional notes required.

**Note:** Indicate height for Café and Double-hung styles in column 14.

### 11 Build-Out

1 = Single build-out (standard frames: 1/2", track systems: 3/4")

2 = Double build-out (standard frames: 1", track systems: 1 1/2")

Other Hang Strip/Light Stop Options:

LS21 = 1/4"    LS22 = 1/2"    HS21 = 3/4"    HS22 = 1"

### 12 Tilt Bar

F = Front center

L = Lantana™ gear system

FH = Front hinge side

RH = Rear hinge side†

SP = Split tilt (Enter height of split) \*Note: 3/4" clearance required for TruView™ rear tilt.

### 13 Valance Type (Track Systems Only)

S = Standard valance (Bi-fold only)    D = Deluxe valance

### 14 Divider Rail/Café/Double-Hung Height

DR1 = First divider rail (required for panel heights over 60")

DR2 = Second divider rail (required for panel heights over 90")

**Note:** Enter "C" if the desired location is at the center of the panel.

### 15 T-Post

EQ = T-post placed to provide equally divided openings

For uneven placement, always start from the left, indicate distance in inches from left side of shutter to center of each T-post.

### 16 Closure System

D = Duracatch™    M = Magnets    N = None

All 4-sided standard units come with Duracatch panel lock system.

### 17 Astragal

S = Standard

SA = Special Application

**Note:** In the appropriate opening box draw an Astragal symbol on the panel configuration from box 9. †

**Note:** Single units come standard with flex light block. Multiple panels come standard with rear astragal and flex light block.

### 18 Rail Size

2 = 2" top and bottom rail

4 = 4" top and bottom rail

**Note:** Default rail size on panels under 36" is a 2" rail.

### Lineal Materials

Grid prices include standard frames, T-posts, buildout and hardware. To order additional lineal materials, indicate quantity, color and length.



# Express™ NewStyle® Order Form Key

Use the following key as a guide when completing the order form for Express™ NewStyle® hybrid shutters.

## 1 Color

Specify color number and name.

650 = Pure White    651 = Soft White    652 = Warm Cream

## 2 Hinge Color

Specify hinge color number and name.

009 = White (standard with 650 Pure White)

010 = Off-White (standard with 651 Soft White & 652 Warm Cream)

## 3 Louver Size

Specify louver size: 2 1/2" or 3 1/2".

## 4 IM or OM

Specify inside mount or outside mount.

**IM** = Inside Mount

Factory takes a standard framed deduction of 1/4" from width and height or a standard without frame deduction of 3/16" from width and height.

On all inside mounts, diagonal measurements must be taken. If diagonal measurements are not equal, consider making greater deductions than the standard 1/4" (framed) or 3/16" (without frame). If the diagonal measurement difference is greater than 1/2", we recommend an outside mount for that particular window opening.

**OM** = Outside Mount

Factory takes no deductions. Submitted size will be the finished shutter size.

When measuring the opening of a typical window for outside mounts, we recommend adding the width of the base of the frame plus 1/4", per framed side, to the largest width and height measurements. This provides a 1/4" reveal around the entire window opening.

Standard additions:

Frame Type	3-Sided Frame		4-Sided Frame	
	Width	Height	Width	Height
L10	2 3/4"	1 3/8"	2 3/4"	2 3/4"

## 5 Frame Type (I) = Inside Mount, (O) = Outside Mount

Z10 = Trim Z-frame (I)

L10 = Trim L-frame (I or O)

HSS = Hang strip side-by-side

HSB = Hang strip behind

WF = Without frame (panels only)

Note: All HS frames are based on two hang strips, left and right. On inside mounts, two light stops top and bottom are included.

## 6 Rough Measure

Enter rough measurements and number of panels. This will be used as a guide for price estimates and configurations until a final measure is performed by a trained installer.

## 7 Ordered Size

Enter width and height dimensions to the nearest 1/16".

## 8 Number of Panels Per Opening

1 = One panel    2 = Two panels    4 = Four panels

## 9 Panel Configuration

Print the letters of the panel configuration. See the following examples:

One Panel Left



One Panel Right



Two Panels

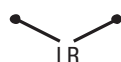

Four Panels with One T-Post



Then, in the appropriately numbered box, draw the panel configuration. Include the letters of the configuration.

## 10 Frame Detail

2 = 2-sided; 3 = 3-sided (top, left, right); 4 = 4-sided

4SIL = 3-sided L-frame or Z-frame with bottom sill frame†

3D = 3-sided door which provides 5/8" floor clearance

† When using L-frame instead of bottom sill frame indicate with "-L".

## 11 Build-Out

1 = Single build-out projection

L10

1 3/8"

## 12 Tilt Bar

F = Traditional front center tilt bar with upward closure

## 13 Valance Type (Track Systems Only)

Not available with Express NewStyle program.

## 14 Divider Rail/Double-Hung/Café Height

DR1 = First divider rail (required for panel heights over 60")

DR2 = Second divider rail (required for panel heights over 90")

Note: Enter "C" if the desired location is at the center of the panel.

For OM (outside mount): Enter measurement(s) from bottom of frame to center of divider rail(s).

For IM (inside mount): Enter measurement(s) from inside bottom of window to center of divider rail(s).

## 15 T-Post

EQ = Only equally spaced T-posts available

## 16 Magnets

All 4-sided frames come standard with pre-installed magnets.

Y = Yes, pre-install    N = No, do not pre-install

## Lineal Materials

Grid prices include standard frames, T-posts and hardware.

To order additional lineal materials, indicate quantity, color and length.

HS10 = Hang strip

LS = Light stop

# HunterDouglas

HERITANCE®

Hardwood Shutters

NEWSTYLE®

Hybrid Shutters

PALM BEACH™

Polysatin Shutters

BRIDGEWAY®

Specialty Shapes

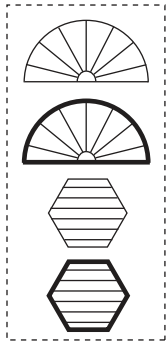

## STAND-ALONE SPECIALTY SHAPE UNFRAMED AND FRAMED ORDER FORM

BILL TO:		Date:	SHIP VIA:	Page _____ of _____
		Account #:	<input type="checkbox"/> Will Call	Job #:
		P.O. #:	<input type="checkbox"/> Delivery Service	
SHIP TO:		Ordered by:	<input type="checkbox"/> Ship	
		Sidemark:		
		Phone #:	Fax #:	

See the reverse side for the specialty shapes order explanation key (1 - 5).

Opening #	Room	Qty.	1 Specialty Type	2 Product Code	3 Color Number	4 Hinge Color Number <sup>1</sup>	5 Mounting Style			6 Frame Type <sup>3</sup>	Opening Measurements	7 Returns <sup>2</sup>	8 Companion Specialty	9 Buildout	10 T1-T4 & PB Louver Size	11 T1-T4 & PB Tilt Option	12 Vertical Support (Palm Beach Only)		13 Price	Special Instructions	
							OM	IM	EX <sup>2</sup>								1st	2nd			
										COMPLETE WORKSHEET SECTION BELOW. A = Opening Width B = Opening Height C = Opening Rise D = Opening Center Height											

<sup>1</sup>Heritage® framed only <sup>2</sup>Unframed only, not applicable to Palm Beach™ <sup>3</sup>Heritage and Palm Beach framed only If you think you may have a variable radius shape, please supply a template. Note that templates will affect lead time and may incur additional surcharge.

### 14 Specialty Shape Types and Measurements Required

*No Template Required — Specialty Shapes with Sunburst Louvers in Heritage, NewStyle® and Bridgeway® and Horizontal Louvers in Palm Beach*

**Perfect Arch (A1)**  
HH, NS, PB & BW

A = Opening Width  
B = Opening Height  
C = Opening Rise  
D = Opening Center Height

**Quarter Circle (A2)**  
HH, NS, PB & BW

A2L Left A2R Right

**Circle (A3)**  
HH, NS & BW

**Extended Eyebrow or Extended Arch (A4)**  
HH, NS, PB & BW

Extended Arch

**Eyebrow (A5)**  
HH, NS, PB & BW

**Extended Quarter Eyebrow (A6)**  
HH, NS & BW

A6L Left A6R Right

**Extended Angle or Angle (A7)**  
HH, NS & BW

A7L Left A7R Right

### 15 Specialty Shapes with Horizontal Louvers

*Heritage Only — Template Required*

**Oval (T1)**

**Circle (T2)**

**Hexagon (T3)**

**Octagon (T4)**

### 16 Measurements and Overlaps

Opening # _____ Specialty Type _____ A = _____ B = _____ C = _____ D = _____ <div style="text-align: center; margin-top: 10px;"> <input type="text"/>                      Top Overlap                 </div> <div style="display: flex; justify-content: space-between; margin-top: 10px;"> <div style="text-align: center;"><input type="text"/> Left Overlap</div> <div style="text-align: center;"><input type="text"/> Right Overlap</div> </div> <div style="text-align: center; margin-top: 10px;"> <input type="text"/>                      Bottom Overlap                 </div> <p>Clearance Depth _____                  Overall Width for Pricing _____</p>	Opening # _____ Specialty Type _____ A = _____ B = _____ C = _____ D = _____ <div style="text-align: center; margin-top: 10px;"> <input type="text"/>                      Top Overlap                 </div> <div style="display: flex; justify-content: space-between; margin-top: 10px;"> <div style="text-align: center;"><input type="text"/> Left Overlap</div> <div style="text-align: center;"><input type="text"/> Right Overlap</div> </div> <div style="text-align: center; margin-top: 10px;"> <input type="text"/>                      Bottom Overlap                 </div> <p>Clearance Depth _____                  Overall Width for Pricing _____</p>	Opening # _____ Specialty Type _____ A = _____ B = _____ C = _____ D = _____ <div style="text-align: center; margin-top: 10px;"> <input type="text"/>                      Top Overlap                 </div> <div style="display: flex; justify-content: space-between; margin-top: 10px;"> <div style="text-align: center;"><input type="text"/> Left Overlap</div> <div style="text-align: center;"><input type="text"/> Right Overlap</div> </div> <div style="text-align: center; margin-top: 10px;"> <input type="text"/>                      Bottom Overlap                 </div> <p>Clearance Depth _____                  Overall Width for Pricing _____</p>	Opening # _____ Specialty Type _____ A = _____ B = _____ C = _____ D = _____ <div style="text-align: center; margin-top: 10px;"> <input type="text"/>                      Top Overlap                 </div> <div style="display: flex; justify-content: space-between; margin-top: 10px;"> <div style="text-align: center;"><input type="text"/> Left Overlap</div> <div style="text-align: center;"><input type="text"/> Right Overlap</div> </div> <div style="text-align: center; margin-top: 10px;"> <input type="text"/>                      Bottom Overlap                 </div> <p>Clearance Depth _____                  Overall Width for Pricing _____</p>
---	---	---	---



# HunterDouglas

HERITANCE®

Hardwood Shutters

NEWSTYLE®

Hybrid Shutters

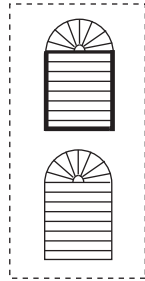

## CONTINUOUS OPENING UNFRAMED SUNBURST OVER PANELS ORDER FORM

BILL TO:	Date:	SHIP VIA: <input type="checkbox"/> Will Call <input type="checkbox"/> Delivery Service <input type="checkbox"/> Ship	Page _____ of _____
	Account #:		Job #:
	P.O. #:		
SHIP TO:	Ordered by:		
	Sidemark:		
	Phone #:	Fax #:	

**Specialty shape order:** See the specialty shapes order explanation key for more details.

Opening #	Room	Qty.	1 Specialty Type	2 Product Code	3 Color Number	4 Mounting Style OM IM	Opening Measurements		5 Returns <sup>1</sup>	6 Companion Specialty	7 Buildout	8 Adders for Overlap				9 Width for Pricing	10 Price	Special Instructions
							A	B				Left	Top	Right	Bottom			
<b>Complete Worksheet Section Below</b>												0						
A = Opening Width B = Opening Height C = Opening Rise D = Opening Center Height E = Overall Opening Height F = SBS Height												0						

<sup>1</sup>Unframed specialty shapes only

**Standard Panel order:** See Heritance/NewStyle Standard Panel order form explanation key for more details.

Opening #	Room	Qty.	Product Code: HH or NS	1 Color	2 Hinge Color	3 Louver Size	4 IM or OM	5 SBS Frame Type	7 Ordered Size		8 # of Panels Per Opening	9 Panel Configuration	10 Frame Detail	11 Buildout	12 Tilt Bar	13 Track Valance Type	14 Divider Rail Height (Double-Hung and Café Height)	15 T-Post				16 Magnets
									Width	Height								1st	2nd	3rd	4th	
																	DR2	1st	2nd	3rd	4th	
																	DR1					
																	DR2	1st	2nd	3rd	4th	
																	DR1					

NOTES: IM (Inside Mount) = Factory takes deductions. OM (Outside Mount) = Finished shutter size. See key for Heritance or NewStyle order form key or Reference Guide for more details.

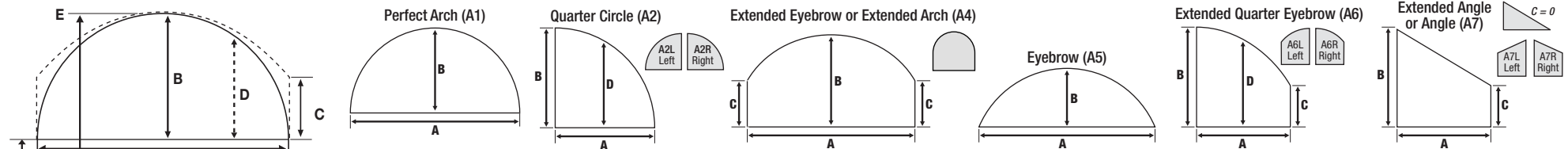

Specialty	Shutter Below Specialty	Specialty	Shutter Below Specialty
Opening # _____ Specialty Type _____	WINDOW DIAGONAL: Left _____ Right _____	Opening # _____ Specialty Type _____	WINDOW DIAGONAL: Left _____ Right _____
A = _____ B = _____	CLEARANCE DEPTH _____	A = _____ B = _____	CLEARANCE DEPTH _____
C = _____ D = _____	TRIM TO TRIM <input type="checkbox"/>	C = _____ D = _____	TRIM TO TRIM <input type="checkbox"/>
E = _____ F = _____ (SBS)	←	E = _____ F = _____ (SBS)	←
Left Overlap Top Overlap Right Overlap	←	Left Overlap Top Overlap Right Overlap	←
	↓ ↓ ↓		↓ ↓ ↓
NOTES:	6 Rough Measure _____ X _____	NOTES:	6 Rough Measure _____ X _____

# CONTINUOUS OPENING UNFRAMED SUNBURST OVER PANELS ORDER FORM KEY

Use the following key as a guide when completing the shutter specialty shapes order form. Items marked with an asterisk (\*) require a surcharge.

**1 Specialty Type:** Use specialty shape symbol identified on front  
**EXAMPLE:** A1 = Perfect Arch

**2 Product Code:** HH = Heritage® hardwood shutters  
 NS = NewStyle® hybrid shutters  
 BW = Bridgeway® specialty shapes

**3 Color Number:** Specify color number.

**4 Mounting Style:**  
 OM = Outside mount overlaps the window opening.  
 IM = Inside mount fits within the window opening.

**5 Returns:** *Unframed specialty shapes only.*  
**YES** = Include returns on the specialty shape.  
**NO** = Do not include returns on the specialty shape; or inside mount (IM).

Returns on quarter circles and extended quarter eyebrows are both vertical and horizontal, as shown at right. If a return is desired in one direction, but not in the other, indicate this in Special Instructions.

*Note:* Returns add 1/2" per side or 1" overall. Returns are not available on T1 - T4 specialty shapes or inside mount applications.

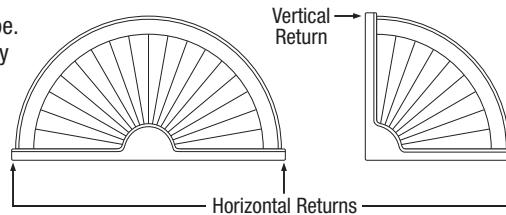

**6 Companion Specialty:**  
**YES** = This is a companion specialty.  
**NO** = This is not a companion specialty.

Companion specialty example:

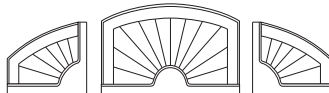

**7 Buildout:**  
 1 = Single buildout projection\*  
 2 = Double buildout projection\*  
 Buildout projection comes preattached to the back of the specialty shape.

	NewStyle Bridgeway	Heritage Unframed	Heritage Framed	
			L1	L2
Single Buildout	1"	1"	1 1/8"	1 3/8"
Double Buildout	2"	2"	2 1/4"	2 3/4"

**8 Adders for Overlap:**  
 For specialty shape outside mounts (OM) only, use the overlap at right to determine the overlap of the shape around the opening and the ordered width for pricing.

When the shutter below is framed inside mount (IM), using any Z-Frame, the specialty above should be an outside mount to line up with the shutter below. Use the correct overlap to the right to determine the overlap around the opening and the ordered width for pricing.



When the shutter below is inside mount (IM) hangstrip or direct mount, the specialty should be an inside mount (IM) and there would be no frame adder.

### Unframed Specialty Over Outside Mount Shutter Below

Recommended overlap per side (includes 1/4" reveal):

Heritage Frames	NewStyle Frames
L1 = 1 5/8"    L2 = 1 3/8"	L10 = 1 3/8"    L11 = 1 5/8" L12 = 1 3/8"

### Unframed Specialty Over Inside Mount Shutter Below

Recommended overlap per side (includes 1/4" reveal):

Heritage Frames	NewStyle Frames
Z1 = 7/8"    Z2 = 1 15/16"	Z11 = 1"    Z12 = 1 5/8"
Z3 = 1 5/8"    Z4 = 1"	

**9 Width for Pricing:** Opening width plus the left and right overlap.

**10 Price:** See base price grid in the appropriate section of the Hunter Douglas *Full-Line Reference Guide & Base Price List*.

**Measurements:** Identify opening # and specialty type in space provided. Enter appropriate A, B, C, D, E and F measurements.  
 A = Opening Width  
 B = Opening Height  
 C = Opening Rise  
 D = Opening Center Height  
 E = Overall Opening Height  
 F = SBS Height. For (IM) the opening height for the shutter below the specialty.  
 For (OM) the framed shutter height of the shutter below the specialty

**Variable Radius:** Worksheets and order forms have been designed to effectively replace templates for most openings. Variable radius openings are an exception and require an accurate template. If you have a variable radius arch such as the three examples to the left, send a template. **Note that templates affect lead time.**



# CONTINUOUS OPENING: ARCH/ANGLE TOP PANELS AND FRAMED SUNBURST SPECIALTY OVER PANELS ORDER FORM

## HunterDouglas

HERITANCE®

Hardwood Shutters

NEWSTYLE®

Hybrid Shutters



BILL TO:  SHIP TO:	Date:  Account #:  P.O. #:  Ordered by:  Sidemark:  Phone #:  Fax #:  	SHIP VIA: <input type="checkbox"/> Will Call <input type="checkbox"/> Delivery Service <input type="checkbox"/> Ship	Page _____ of _____  Job #:  
--------------------------	--	---	---

Use the order form key for the standard Heritance and NewStyle order forms as a guide for filling in this order form **1 - 16**

Opening #	Room	Qty.	Product Code HH or NS	Color 1	Hinge Color 2	Louver Size 3	IM or OM 4	Frame Type 5	Measurements 6 & 7	# of Panels Per Opening 8	Panel Configuration 9	Frame Detail 10	Buildout <sup>1</sup> (surcharge) 11	Tilt Bar 12	Track Balance Type 13	Divider Rail Height <sup>2</sup> (Double-Hung and Café Height) 14		T-Post 15				Magnets 16	
																DR2	DR1	1st	2nd	3rd	4th		
									Fill in appropriate measurements below. Refer to key on the back of order form.								DR2	DR1	1st	2nd	3rd	4th	
																	DR2	DR1	1st	2nd	3rd	4th	

NOTES: IM (Inside Mount) = Factory takes deductions. OM (Outside Mount) = Finished shutter size. <sup>1</sup>Buildout for specialty area requires surcharge. <sup>2</sup>Entire divider rail must be below shoulder. See order form key or Reference Guide for details.

<div style="border: 1px solid black; padding: 5px;"> <p><b>Arch Top Panel</b></p> <p>Opening # _____</p> <p>(W) Width = _____</p> <p>(OH) Overall Height = _____</p> <p>(SH) Shoulder = _____</p> <p>(CH) Center Height = _____</p> </div> <div style="border: 1px solid black; padding: 5px; margin-top: 5px;"> <p>WINDOW DIAGONAL: Left _____ Right _____</p> <p>CLEARANCE DEPTH _____</p> <p>TRIM TO TRIM <input type="checkbox"/></p> <p><input type="checkbox"/> L <input type="checkbox"/> R</p> </div>	<div style="border: 1px solid black; padding: 5px;"> <p><b>Angle Top Panel</b></p> <p>Opening # _____</p> <p>(W) Width = _____</p> <p>(OH) Overall Height = _____</p> <p>(SH) Shoulder = L _____ R _____</p> <p>(PL) Peak Location = _____</p> </div> <div style="border: 1px solid black; padding: 5px; margin-top: 5px;"> <p>WINDOW DIAGONAL: Left _____ Right _____</p> <p>CLEARANCE DEPTH _____</p> <p>TRIM TO TRIM <input type="checkbox"/></p> <p><input type="checkbox"/> L <input type="checkbox"/> R</p> </div>
<div style="border: 1px solid black; padding: 5px;"> <p><b>Framed Arch Sunburst Continuous Opening - Heritance Only</b></p> <p>Opening # _____ Specialty Type _____</p> <p>(W) Width = _____</p> <p>(OH) Overall Height = _____</p> <p>(SH) Shoulder = _____</p> <p>(CH) Center Height = _____</p> <p>(HTH) Horiz T-Post = _____</p> </div> <div style="border: 1px solid black; padding: 5px; margin-top: 5px;"> <p>WINDOW DIAGONAL: Left _____ Right _____</p> <p>CLEARANCE DEPTH _____</p> <p>TRIM TO TRIM <input type="checkbox"/></p> <p><input type="checkbox"/> L <input type="checkbox"/> R</p> </div>	<div style="border: 1px solid black; padding: 5px;"> <p><b>Framed Angle Sunburst Continuous Opening - Heritance Only</b></p> <p>Opening # _____ Specialty Type _____</p> <p>(W) Width = _____</p> <p>(OH) Overall Height = _____</p> <p>(SH) Shoulder = L _____ R _____</p> <p>(HTH) Horiz T-Post = _____</p> <p>(PL) Peak Location = _____</p> </div> <div style="border: 1px solid black; padding: 5px; margin-top: 5px;"> <p>WINDOW DIAGONAL: Left _____ Right _____</p> <p>CLEARANCE DEPTH _____</p> <p>TRIM TO TRIM <input type="checkbox"/></p> <p><input type="checkbox"/> L <input type="checkbox"/> R</p> </div>

# CONTINUOUS OPENING: ARCH/ANGLE TOP PANELS AND FRAMED SUNBURST SPECIALTY OVER PANELS ORDER FORM KEY

Use the order form key for the standard Heritage and NewStyle order forms as a guide for filling in this order form **4** - 16

## Arch Top Panels Systems:

Covers specialty shape openings with specialty shaped continuous panels.

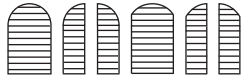

- All louvers will be horizontal with arch top panel systems.
- The shoulder is the point where the arch begins. Some louvers will be fixed closed in the arched area.
- The divider rail cannot be placed in the arched area.

Required measurements enter to the nearest 1/16". For all measurements refer to the Heritage or NewStyle standard order form key code **4** for IM or OM.

Note: IM (Inside Mount) = Use smallest inside opening measure, factory will take appropriate deductions. OM (Outside Mount) = Finished shutter size.

**(W) Width** = Record width

**(OH) Overall Height** = Record the tallest measurement

**(SH) Shoulder Height** = Measure the left and right heights and record for the smallest of the two for IM and the largest of the two for OM.<sup>1</sup>

**(CH) Center Height** = Only needed for quarter arches. Record the height of the center of the window.



Indicate left or right where applicable.

## Angle Top Panels Systems:

Continuous panels in a specialty shape opening that can be a full or half angle.



- All louvers will be horizontal with angle top panel systems.
- The shoulder is the point where the angle begins. Some louvers will be fixed closed in the angled area.
- The divider rail cannot be placed in the angled area.

Required measurements enter to the nearest 1/16". For all measurements refer to the Heritage or NewStyle standard order form key code **4** for IM or OM.

Note: IM (Inside Mount) = Use smallest inside opening measure, factory will take appropriate deductions. OM (Outside Mount) = Finished shutter size.

**(W) Width** = Record width

**(OH) Overall Height** = Record the tallest measurement

**(SH) Shoulder Height** = Measure and record both the left and right heights.<sup>1</sup>

**(PL) Peak Location** = For full angles only, measure from the ordered left to the peak center.



Indicate left or right where applicable.

## Framed Arch Sunburst Continuous Opening: Heritage Only

Hinged sunburst style specialty shape over standard shutter panels separated by a horizontal t-post within a single continuous frame.

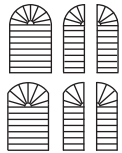

**Specialty Type** = Record type of sunburst specialty to be used for framed pricing.



Required measurements enter to the nearest 1/16". For all measurements refer to the Heritage or NewStyle standard order form key code **4** for IM or OM.

Note: IM (Inside Mount) = Use smallest inside opening measure, factory will take appropriate deductions. OM (Outside Mount) = Finished shutter size.

**(W) Width** = Record width

**(OH) Overall Height** = Record the tallest measurement

**(SH) Shoulder Height** = Measure the left and right heights and record for the smallest of the two for IM and the largest of the two for OM.<sup>1</sup>

**(CH) Center Height** = Only needed for quarter arches. Record the height of the center of the window.

**(HTH) Horizontal T-Post Height** = Record the height from the ordered bottom t-post center line.<sup>2</sup>



Indicate left or right where applicable.

## Framed Angle Sunburst Continuous Opening: Heritage Only

Sunburst style shape over panels with continuous frame housing both.

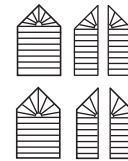

**Specialty Type** = Record type of sunburst specialty to be used for framed pricing.

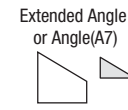

Required measurements enter to the nearest 1/16". For all measurements refer to the Heritage or NewStyle standard order form key code **4** for IM or OM.

Note: IM (Inside Mount) = Use smallest inside opening measure, factory will take appropriate deductions. OM (Outside Mount) = Finished shutter size.

**(W) Width** = Record width

**(OH) Overall Height** = Record the tallest measurement

**(SH) Shoulder Height** = Measure and record both the left and right heights.<sup>1</sup>

**(HTH) Horizontal T-Post Height** = Record the height from the ordered bottom t-post center line.<sup>2</sup>

**(PL) Peak Location** = For full angles only, measure from the ordered left to the peak center.



Indicate left or right where applicable.

### <sup>1</sup>Outside Mount Shoulder Location

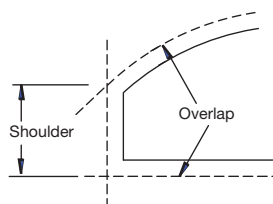

At the shoulder area of a specialty shutter, the overlap portion of the frame will always be less than the normal frame overlap therefore it is important to measure the shoulder height correctly. To find the correct shoulder height:

1. Determine the appropriate frame adder by consulting box **4** of the standard order form key code.
2. Mark the wall on the left side and the top of the opening to show where the frame will overlap.
3. The shoulder will be the point where the vertical line intersects with the arc or angle from the top (see drawing).

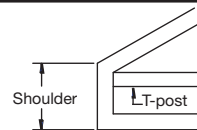

### <sup>2</sup>T-post and Divider Rail Placement Guidelines

- Entire height of a horizontal t-post or divider rails must always be below the shoulder.
- Finished location may vary up or down from the specified location.



**Variable Radius** Worksheets and order forms have been designed to effectively replace templates for most openings. Variable radius openings are an exception and require an accurate template. If you have a variable radius arch such as the three examples to the left, send a template. **Note that templates affect lead time.**

# HunterDouglas

**PALM BEACH™**  
Polysatin Shutters

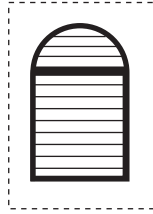

## CONTINUOUS OPENING FRAMED SPECIALTY OVER PANELS ORDER FORM

BILL TO:	Date:	SHIP VIA: <input type="checkbox"/> Will Call <input type="checkbox"/> Delivery Service <input type="checkbox"/> Ship	Page _____ of _____
	Account #:		Job #:
	P.O. #:		
SHIP TO:	Ordered by:		
	Sidemark:		
	Phone #:	Fax #:	

**Specialty Shape order:** See the Palm Beach specialty shapes order explanation key for more details.

Opening #	Room	Qty.	1 Specialty Type	2 Color Number	3 Louver Size	4 Mounting Style OM IM	5 Frame Type	Opening Measurements				6 Companion Specialty	7 Buildout	8 Tilt Option	9 Adders for Overlap Left Top Right Bottom			10 Vertical Support		11 Width for Pricing	12 Price	Special Instructions				
								A	B	C	D				E	F	1st	2nd	1st				2nd			
Complete Worksheet Section Below																										
A = Opening Width B = Opening Height																										
C = Opening Rise D = Opening Center Height																										
E = Overall Opening Height F = SBS Height																										

**Standard Panel order:** See Palm Beach Standard Panel order form explanation key for more details.

Opening #	Room	Qty.	Color 1	Hinge Color 2	Louver Size 3	IM or OM 4	SBS Frame Type 5	7 Ordered Size		# of Panels Per Opening 8	Panel Configuration 9	Frame Detail 10	Buildout 11	Tilt Bar 12	Track Valance Type 13	Divider Rail Height 14	15 T-Post				Closure System 16	Astragal 17	Rail Size 18
								Width	Height								1st	2nd	3rd	4th			
																DR2	1st	2nd	3rd	4th			
														SP		DR1							
																DR2	1st	2nd	3rd	4th			
														SP		DR1							

NOTES: IM (Inside Mount) = Factory takes deductions. OM (Outside Mount) = Finished shutter size. See key for Palm Beach order form key or Reference Guide for more details.

**13 Measurements**

**Perfect Arch (A1)**

**Quarter Circle (A2)**

**Extended Eyebrow or Extended Arch (A4)**

**Eyebrow (A5)**

**Specialty**  
Opening # \_\_\_\_\_ Specialty Type \_\_\_\_\_  
A = \_\_\_\_\_ B = \_\_\_\_\_  
C = \_\_\_\_\_ D = \_\_\_\_\_  
E = \_\_\_\_\_ F = \_\_\_\_\_ (SBS)

Left Overlap    Top Overlap    Right Overlap

**Shutter Below Specialty**  
WINDOW DIAGONAL: Left \_\_\_\_\_ Right \_\_\_\_\_  
CLEARANCE DEPTH \_\_\_\_\_  
TRIM TO TRIM

↓    ↓    ↓

6 Rough Measure \_\_\_\_\_ X \_\_\_\_\_

**Specialty**  
Opening # \_\_\_\_\_ Specialty Type \_\_\_\_\_  
A = \_\_\_\_\_ B = \_\_\_\_\_  
C = \_\_\_\_\_ D = \_\_\_\_\_  
E = \_\_\_\_\_ F = \_\_\_\_\_ (SBS)

Left Overlap    Top Overlap    Right Overlap

**Shutter Below Specialty**  
WINDOW DIAGONAL: Left \_\_\_\_\_ Right \_\_\_\_\_  
CLEARANCE DEPTH \_\_\_\_\_  
TRIM TO TRIM

↓    ↓    ↓

6 Rough Measure \_\_\_\_\_ X \_\_\_\_\_

# CONTINUOUS OPENING FRAMED SPECIALTY OVER PANELS ORDER FORM KEY

Use the following key as a guide when completing the Palm Beach shutter specialty shapes order form. Items marked with an asterisk (\*) require a surcharge.

**1 Specialty Type:** Identify shape type  
 A1 = Perfect arch                      A4 = Extended eyebrow or extended arch  
 A2L = Left quarter circle            A5 = Eyebrow  
 A2R = Right quarter circle

**2 Color Number:** Specify color number.  
 051 = White Silk                      136 = Bright White  
 137 = White                              138 = Linen

**3 Louver Size:** Comes standard with horizontal louvers.  
 Specify louver size: 2 1/2" or 3 1/2"

**4 Mounting Style:**  
 OM = Outside mount overlaps the window opening.  
 IM = Inside mount fits within the window opening.

**5 Frame/Sill Combinations:** Specify frame combination.  
 Framed arch must include sill at bottom and shutter unit must include sill at top. See drawing below.

Z21/L21 = Standard Z-frame	L21/L21 = Standard L-frame
Z22/S22 = Decorative Z-frame	C21/S21 = Deluxe Casing frame
S22/S22 = Decorative Z-frame Sill	S21/S21 = Deluxe Casing frame Sill
Z23/L21 = Colonial Z-frame	

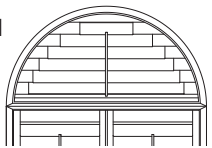

Framed arch with sill at bottom and shutter unit with sill at top.

**6 Companion Specialty:**  
 YES = This is a companion specialty.  
 NO = This is not a companion specialty.

Companion specialty example:

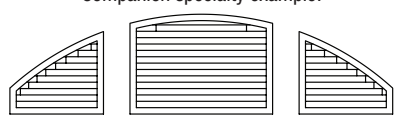

**7 Buildout:**  
 1 = Single buildout projection\*  
 2 = Double buildout projection\*  
 Buildout projection comes preattached to the back of the specialty shape.

	Palm Beach: L21, C21, S21
Single Buildout	1/2"
Double Buildout	1"

**8 Tilt Options:**  
 F = Front tilt                      R = Rear tilt (Only if the arch has a full length straight side or vertical support.)

**9 Adders for Overlap:**  
 For specialty shape outside mounts (OM) only, use the overlap below to determine the overlap of the shape around the opening and the ordered width for pricing.

**Framed Outside Mount**  
 Recommended width overlap per side (with 1/4" reveal):  
 Palm Beach Frames: L21 = 1 9/16"  
                                   C21 = 2 15/16"  
                                   S21 = 1 9/16"

**10 Vertical Support:**  
 EQ = Vertical support placed to provide equally divided openings.  
 For uneven placement, always start from the left, indicate distance in inches from left side of shutter to center of each vertical support.  
**Note:** In order to achieve a consistent look, order the shutter below and the arch above with the same number of panels and sections. Vertical supports are required on shapes over 30" wide.

**11 Width for Pricing:** Opening width plus the left and right overlap.

**12 Price:** See base price grid in the appropriate section of the Hunter Douglas *Full-Line Reference Guide & Base Price List*.

**13 Measurements:** Identify opening # and specialty type in space provided. Enter appropriate A, B, C, D, E and F measurements.

A = Opening Width  
 B = Opening Height  
 C = Opening Rise  
 D = Opening Center Height  
 E = Overall Opening Height  
 F = SBS Height. For (IM) the opening height for the shutter below the specialty.  
 For (OM) the framed shutter height of the shutter below the specialty

**Outside Mount Rise Location**

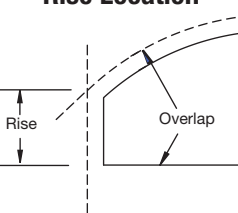

At the rise area of a specialty shutter, the overlap portion of the frame will always be less than the normal frame overlap therefore it is important to measure the rise correctly. To find the correct rise:

- Determine the appropriate frame adder by consulting box 9 of the standard order form key code.
- Using the frame adders, mark the wall on the left side and the top of the opening to show where the frame will overlap.
- The rise will be the point where the vertical line intersects with the arc or angle from the top (see drawing).

**Variable Radius:** Worksheets and order forms have been designed to effectively replace templates for most openings. Variable radius openings are an exception and require an accurate template. If you have a variable radius arch check for availability.  
**Note that templates affect lead time and may incur additional surcharges.**



Product Key: **HH** = Heritage® Hardwood Shutters; **NS** = NewStyle® Hybrid Shutters; **PB** = Palm Beach™ Polysatin Shutters  
Refer to the appropriate Reference Guide section for specifications.

### L-FRAME OUTSIDE MOUNT

- Using the Hunter Douglas EasyAngle® Tool and allowing for a 3/8" reveal, mark **A**. Repeat this step at the other side and mark **F**.
- Using the EasyAngle® Tool, determine and mark positions **B** and **C**. Repeat this step for **D** and **E**.
- Determine the ordered widths of the three shutters. Measure the distance from mark **A** to mark **B** (opening 1). Repeat for **C** to **D** (opening 2) and **E** to **F** (opening 3). Enter these width measurements in the boxes at right.
- Determine the largest inside height of the openings. Measure the inside height at three places for each opening. Enter the *largest* of these nine measurements in the top box at right.
- Enter the correct **FOF** (Frame Overlap Factor) in the middle box at right.
  - FOF for 4-sided L-frames: **HH & NS** is 3/4", **PB** is 3/8"
  - FOF for 4-sided frame with bottom sill: **HH & NS** is 2 5/8", **PB** is 3 1/8"
  - FOF for Sill frame on window sill: **HH & NS** is 1 5/8", **PB** is 1 9/16"
- Add the largest inside height measurement to the **FOF** to calculate the ordered height. All three shutters should have the same ordered height.

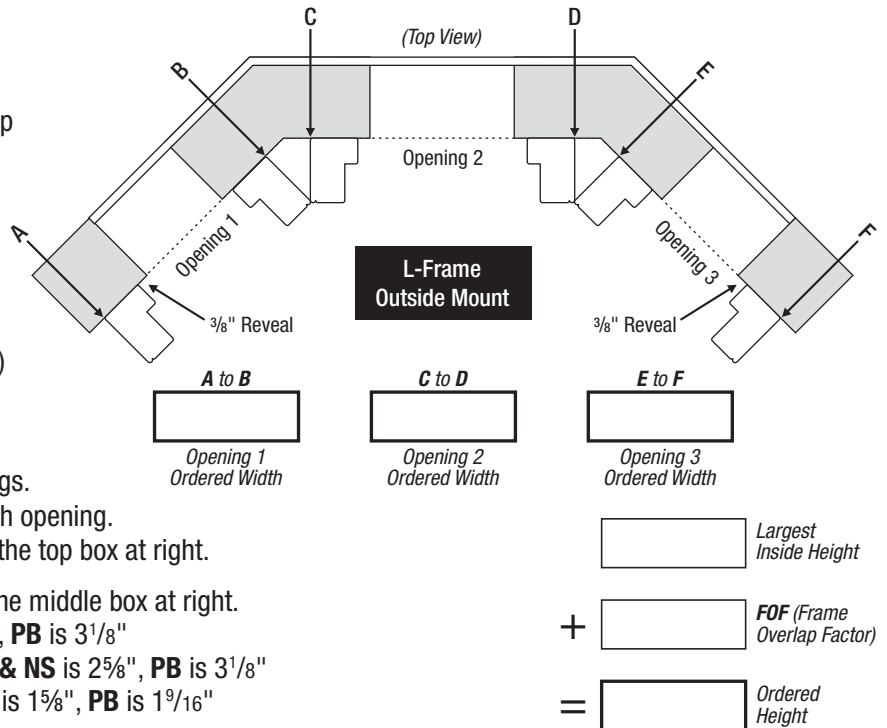

### Z/L-FRAME INSIDE MOUNT

- Using the EasyAngle® Tool, mark positions **B** and **C**. Repeat this step for **D** and **E**.
- Measure inside opening 1 from the wall at **A** to the mark at **B**. This provides a 1/4" space at **A**.
- Measure inside opening 2 from mark **C** to mark **D**. Add 1/4" to determine the ordered width.
- Measure inside opening 3 from the mark at **E** to the wall at **F**. This provides a 1/4" space at **F**.
- Determine the smallest inside height of the openings. Measure the inside height at three places for each opening. Use the *smallest* of these nine measurements as your ordered height for all three shutters.

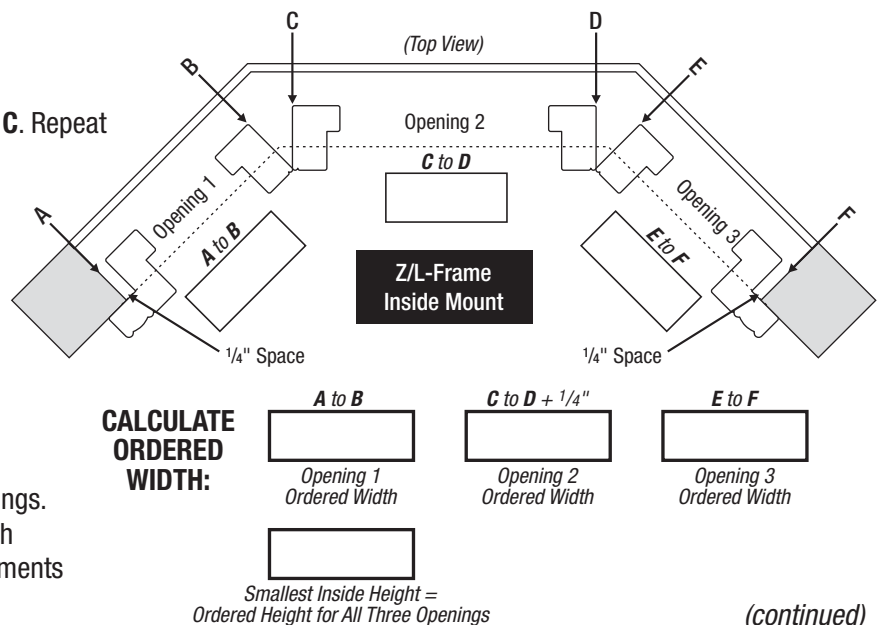

### FOR ALL BAY WINDOW SHUTTERS:

Transfer the information from the worksheet to the Heritage®, NewStyle® or Palm Beach™ order form and indicate that the shutters are for a bay window. Attach this worksheet to the order form.

Order form page number(s) \_\_\_\_\_ Opening numbers \_\_\_\_\_ Sidemark \_\_\_\_\_

### Notes:

- Always check for sufficient clearance and any obstructions which may interfere with louver movement.

# Bay Window Shutters Worksheet *(continued)*

Product Key: **HH** = Heritage® Hardwood Shutters; **NS** = NewStyle® Hybrid Shutters; **PB** = Palm Beach™ Polysatin Shutters

*Refer to the appropriate Reference Guide section for specifications.*

## COLONIAL Z-FRAME INSIDE MOUNT

1. Determine ordered widths. Measure **A** to **B** (Opening 1). Subtract  $1\frac{3}{4}$ " to calculate ordered width.

HH NS PB	<i>A to B</i>		<i>Ordered Width</i>
		$- 1\frac{3}{4}"$	
			<i>Opening 1</i>

2. Measure **C** to **D** (Opening 2). Subtract  $3\frac{1}{4}$ " to calculate ordered width.

HH NS PB	<i>C to D</i>		<i>Ordered Width</i>
		$- 3\frac{1}{4}"$	
			<i>Opening 2</i>

3. Measure **E** to **F** (Opening 3). Subtract  $1\frac{3}{4}$ " to calculate ordered width.

HH NS PB	<i>E to F</i>		<i>Ordered Width</i>
		$- 1\frac{3}{4}"$	
			<i>Opening 3</i>

4. Determine the smallest inside height of the openings. Measure the inside height at three places for each opening. Use the *smallest* of these nine measurements. Subtract  $\frac{1}{8}$ " to calculate your ordered height for all three openings.

HH NS PB		$- \frac{1}{8}"$	
	<i>Smallest Inside Height</i>		<i>Ordered Height for All Three Openings</i>

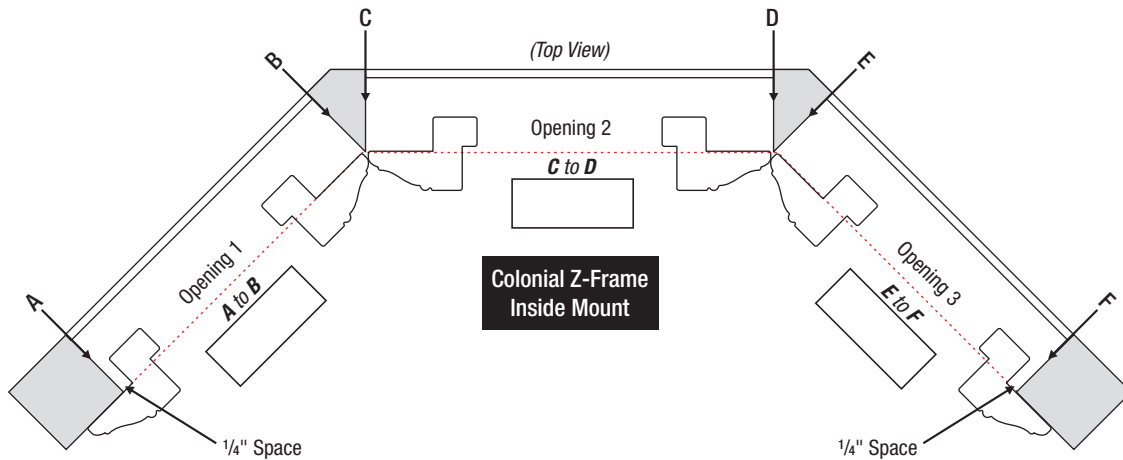

### FOR ALL BAY WINDOW SHUTTERS:

Transfer the information from the worksheet to the Heritage, NewStyle or Palm Beach order form and indicate that the shutters are for a bay window. Attach this worksheet to the order form.

Order form page number(s) \_\_\_\_\_ Opening numbers \_\_\_\_\_ Sidemark \_\_\_\_\_

#### Notes:

- Always check for sufficient clearance and any obstructions which may interfere with louver movement.

Product Key: **HH** = Heritance® Hardwood Shutters; **NS** = NewStyle® Hybrid Shutters; **PB** = Palm Beach™ Polysatin Shutters

Refer to the appropriate Reference Guide section for specifications.

## L-FRAME OUTSIDE MOUNT

- Determine ordered widths. Measure **A** to **B** (Opening 1). For **NS & HH** shutters subtract 2" and for **PB** shutters subtract 2¼" to calculate ordered width.

**HH**  $\frac{A \text{ to } B}{\text{Ordered Width}} - 2" = \text{Ordered Width}$  Opening 1

**NS**  $\frac{A \text{ to } B}{\text{Ordered Width}} - 2" = \text{Ordered Width}$  Opening 1

**PB**  $\frac{A \text{ to } B}{\text{Ordered Width}} - 2\frac{1}{4}" = \text{Ordered Width}$  Opening 1

- Repeat for **C** to **D** (Opening 2).

**HH**  $\frac{A \text{ to } B}{\text{Ordered Width}} - 2" = \text{Ordered Width}$  Opening 2

**NS**  $\frac{A \text{ to } B}{\text{Ordered Width}} - 2" = \text{Ordered Width}$  Opening 2

**PB**  $\frac{A \text{ to } B}{\text{Ordered Width}} - 2\frac{1}{4}" = \text{Ordered Width}$  Opening 2

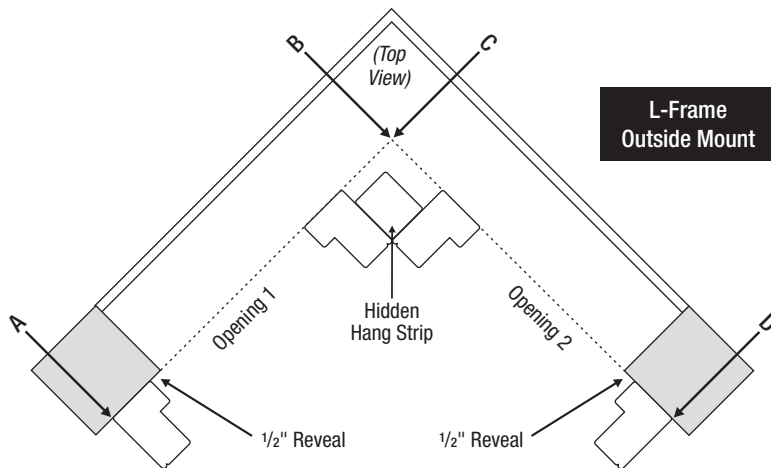

**L-Frame  
Outside Mount**

- Determine the largest inside height of the openings. Measure the inside height at three places for each opening. Enter the *largest* of these six measurements in the top box at right.

Largest Inside Height

- Enter the correct **FOF** (Frame Overlap Factor) in the middle box at right.

- FOF for 4-sided L-frames: **HH & NS** is 3¼", **PB** is 3¹⁄₈"
- FOF for 4-sided frame with bottom sill: **HH & NS** is 2⁵⁄₈", **PB** is 3¹⁄₈"
- FOF for Sill frame on window sill: **HH & NS** is 1⁵⁄₈", **PB** is 1⁹⁄₁₆"

+  **FOF** (Frame Overlap Factor)

- Add the largest inside height measurement to the **FOF** to calculate the ordered height. The ordered height is the same for both shutters.

=  Ordered Height

- Order one length of hangstrip at the ordered height - ¼" and note as lineal materials on the standard order form.

## Z/L-FRAME INSIDE MOUNT

- Determine ordered widths. Measure **A** to **B** (Opening 1). Subtract ¾" to calculate ordered width.

**HH**  $\frac{A \text{ to } B}{\text{Ordered Width}} - \frac{3}{4}" = \text{Ordered Width}$  Opening 1

**NS**  $\frac{A \text{ to } B}{\text{Ordered Width}} - \frac{3}{4}" = \text{Ordered Width}$  Opening 1

**PB**  $\frac{A \text{ to } B}{\text{Ordered Width}} - \frac{3}{4}" = \text{Ordered Width}$  Opening 1

- Repeat for **C** to **D** (Opening 2).

**HH**  $\frac{C \text{ to } D}{\text{Ordered Width}} - \frac{3}{4}" = \text{Ordered Width}$  Opening 2

**NS**  $\frac{C \text{ to } D}{\text{Ordered Width}} - \frac{3}{4}" = \text{Ordered Width}$  Opening 2

**PB**  $\frac{C \text{ to } D}{\text{Ordered Width}} - \frac{3}{4}" = \text{Ordered Width}$  Opening 2

- Determine the smallest inside height of the openings. Measure the inside height at three places for each opening. Use the *smallest* of these six measurements as your ordered height for both shutters.

Smallest Inside Height = Ordered Height for Both Openings

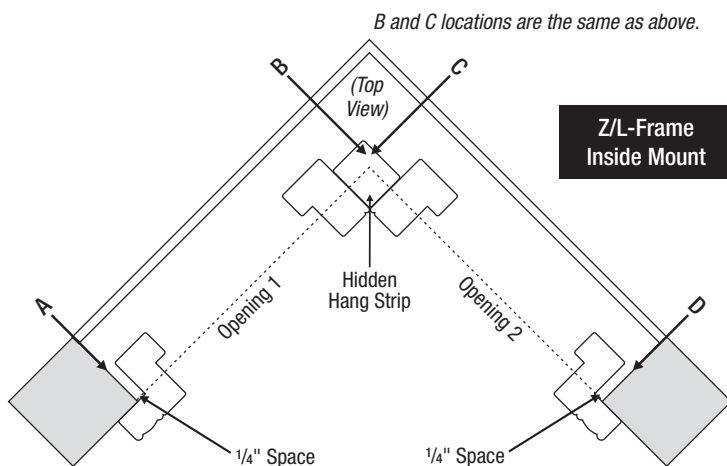

**Z/L-Frame  
Inside Mount**

- Order one length of hangstrip at the ordered height - ¼" and note as lineal materials on the standard order form. (continued)

## FOR ALL CORNER WINDOW SHUTTERS:

Transfer the information from the worksheet to the Heritance, NewStyle or Palm Beach order form and indicate that the shutters are for a corner window. Attach this worksheet to the order form.

Order form page number(s) \_\_\_\_\_ Opening numbers \_\_\_\_\_ Sidemark \_\_\_\_\_

### Notes:

- Always check for sufficient clearance and any obstructions which may interfere with louver movement.

# Corner Window Shutters Worksheet *(continued)*

Product Key: **HH** = Heritage® Hardwood Shutters; **NS** = NewStyle® Hybrid Shutters; **PB** = Palm Beach™ Polysatin Shutters  
 Refer to the appropriate Reference Guide section for specifications.

## COLONIAL Z-FRAME INSIDE MOUNT

1. Determine ordered widths. Measure **A** to **B** (Opening 1). Subtract  $2\frac{1}{8}"$  to calculate ordered width.

HH  <sup>A to B</sup>  
 NS  -  $2\frac{1}{8}"$  =  <sub>Opening 1</sub>  
 PB  <sub>Ordered Width</sub>

2. Repeat for **C** to **D** (Opening 2).

HH  <sup>C to D</sup>  
 NS  -  $2\frac{1}{8}"$  =  <sub>Opening 2</sub>  
 PB  <sub>Ordered Width</sub>

3. Determine the smallest inside height of the openings. Measure the inside height at three places for each opening. Use the *smallest* of these six measurements. Subtract  $\frac{1}{8}"$  to calculate your ordered height for both openings.

HH   
 NS  -  $\frac{1}{8}"$  =   
 PB  <sub>Smallest Inside Height</sub> <sub>Ordered Height for All Three Openings</sub>

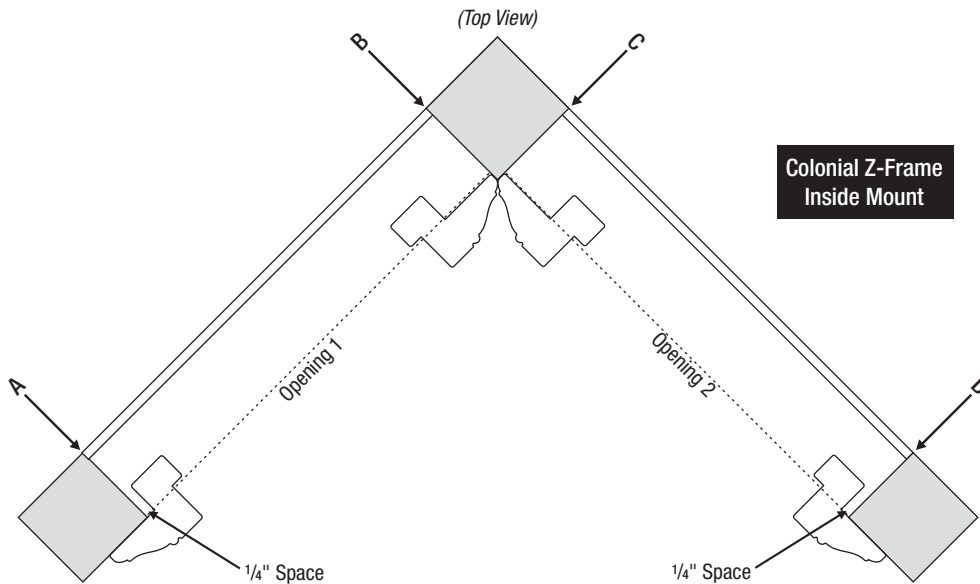

## FOR ALL CORNER SHUTTERS:

Transfer the information from the worksheet to the Heritage, NewStyle or Palm Beach order form and indicate that the shutters are for a corner window. Attach this worksheet to the order form.

Order form page number(s) \_\_\_\_\_ Opening numbers \_\_\_\_\_ Sidemark \_\_\_\_\_

### Notes:

- Always check for sufficient clearance and any obstructions which may interfere with louver movement.

# HunterDouglas

PALM BEACH™

Polysatin Shutters

## French Door Worksheet Round Style Door Knobs

Sidemark

Line Number

Page Number

1. Determine L-frame detail and hinge configuration.

If "A" is less than 3/4"  
enter 3-sided frame



OR

If "A" is 3/4" or more  
enter either a 3-sided  
or 4-sided frame

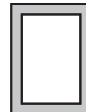

Frame Detail:

3-sided

4-sided

Hinge Detail:

Hinge Left

Hinge Right

2. Determine ordered width for 3 or 4-sided frames.

$$\begin{array}{c} \text{B} \end{array} + \begin{array}{c} \text{A} \end{array} + 1\frac{1}{2}" = \begin{array}{c} \text{Ordered Width} \end{array}$$

(Recommended overlap plus reveal)

3. Determine the ordered height.

$$\begin{array}{c} \text{C} \end{array} + 3" = \begin{array}{c} \text{Ordered Height} \end{array}$$

(Frame Overlap)

4. Determine divider rail location.

$$\begin{array}{c} \text{D} \end{array} + 1\frac{1}{2}" = \begin{array}{c} \text{Divider Rail Location} \end{array}$$

(Frame Overlap on Bottom)

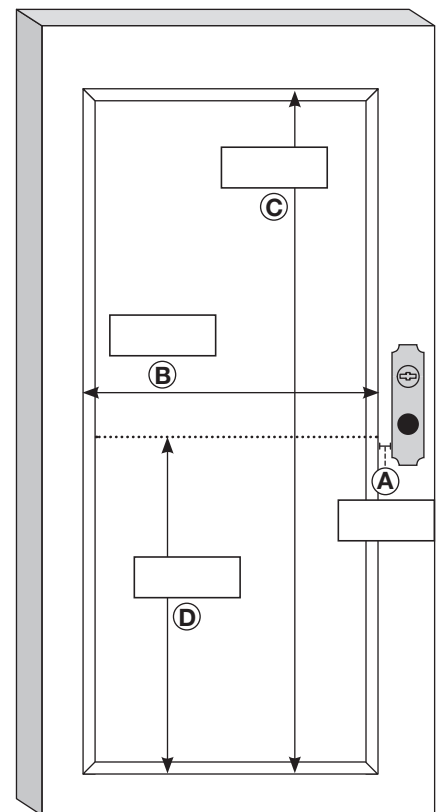

Round Style Knob

### Ordering Notes

1. Transfer final dimensions to your shutter order form.
2. Attach a copy of this worksheet to the order form.
3. Check for louver clearance & order buildout if needed.
4. Split tilt bars are optional in lieu of divider rails.
5. Frame overlap = 1 1/2" per side including reveal.

### Worksheet Key

- A = Distance between the handle baseplate to glass/molding.  
 B = Outside glass/molding measurement width.  
 C = Outside glass/molding measurement height.  
 D = Outside glass/molding measurement to desired divider rail location.

To ensure exact cut-out locations, french door cut-out frame heights may increase up to 4" and 6" depending on louver size. Use this French Door Cut-out worksheet to determine if there is enough room at the bottom and top of the door to accommodate this potential increase. (Key calculations noted in Section 5.)

### 1. Determine frame detail and hinge configuration.

If "A" is less than 3/4" enter 3-sided frame

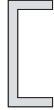

OR

If "A" is 3/4" or more enter either a 3-sided or 4-sided frame

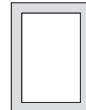

Frame Detail:

- 3-sided  
 4-sided

Hinge Detail:

- Hinge Left  
 Hinge Right

Sidemark

Line Number

Page Number

### 2. Determine ordered width for 3 or 4-sided frames (see ordering note #2 below).

$$\boxed{B} + \boxed{A} \text{ MAX. } 1\frac{1}{2}" + 1\frac{1}{2}" = \boxed{\text{Ordered Width}}$$

*(Recommended overlap including reveal)*

FDC measuring tool must be used to ensure handle rotation

Growth Chart  
Cut-out Distance to Top/Bottom of Frame

### 3. Determine the ordered height (see ordering note #3 below).

$$\boxed{C} + 3" = \boxed{\text{Ordered Height}}$$

*(Recommended top & bottom overlap including reveal)*

### 4. Determine French Door Cut-Out location.

$$\boxed{D} + 1\frac{1}{2}" = \boxed{\text{French Door Cut-Out Location}}$$

*(Recommended overlap including reveal)*

Note: Divider Rails are not available for Palm Beach French Door Cut-out.

### 5. The following calculations help to determine actual finished height with shutter growth.

#### 5a. Determine measurement from center of handle to top of frame.

$$\boxed{E} + 1\frac{1}{2}" = \boxed{\text{Center of Handle to Top Frame}}$$

*(Recommended overlap including reveal)*

#### 5b. To check for your top and bottom growth, consult the growth chart to the right.

$$\boxed{\text{Use French Door Cut-out Location measurement and enter next largest measurement from chart}} + \boxed{\text{Use Center of Handle to Top of Frame measurement and enter next largest measurement from chart}} = \boxed{\text{Actual Finished Height}}$$

Check for adequate F & G clearance to ensure door can accommodate shutter growth.

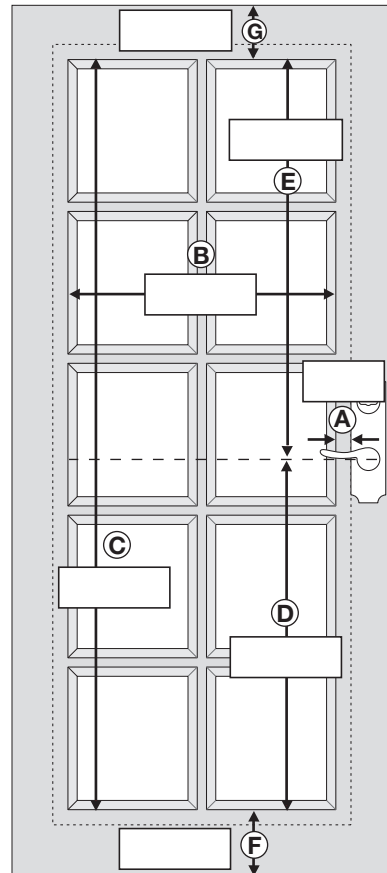

<input type="checkbox"/> 2 1/2" Louver	<input type="checkbox"/> 3 1/2" Louver
14 3/4"	16 1/8"
16 7/8"	19 1/4"
19"	22 3/8"
21 1/8"	25 1/2"
23 1/4"	28 5/8"
25 3/8"	31 3/4"
27 1/2"	34 7/8"
29 5/8"	38"
31 3/4"	41 1/8"
33 7/8"	44 1/4"
36"	47 3/8"
38 1/8"	50 1/2"
40 1/4"	53 5/8"
42 3/8"	
44 1/2"	
46 5/8"	
48 3/4"	
50 7/8"	

### 6. Side-by-side companion door(s) without cut-out:

In some cases, there may be side-by-side companion door(s) that do not require a cut-out. If this is the case, please mark "Yes" below to ensure heights are the same and order as an FDCWC for the companion door on the standard order form: **Companion Door?**  YES  NO **If "Yes", please indicate line #:**  **page #**

### Ordering Notes

- Transfer ordered width and ordered height to your shutter order form and attach worksheet to order.
- L-Frame overlap = 1/2" per side including standard reveal.
- To ensure exact cut-out location, the overall panel height may grow up to 2" top and 2" bottom for a total of 4" growth with 2 1/2" louvers and up to 3" top and 3" bottom for a total of 6" growth for 3 1/2" louvers.
- The french door cut-out is placed behind the handle. A minimum of 3/4" HANDLE PROJECTION is required to clear the cut-out.
- If ordering frame buildout, re-check handle clearance.
- Split tilt bars are optional for wind and light control.
- 7. Not available in 4 1/2" louver or Lantana™.**

### Worksheet Key

- A = Distance between the handle baseplate to glass/molding, maximum of 1 1/2".
- B = Outside glass/molding measurement width.
- C = Outside glass/molding measurement height.
- D = Bottom outside glass/molding measurement to center of handle.
- E = Top outside glass/molding measurement to center of handle.
- F = Distance from bottom of door to bottom of glass/molding.
- G = Distance from top of door to top of glass/molding.

# Heritage® Hardwood Shutters and NewStyle® Hybrid Shutters

## French Door Worksheet

Please check one:

- French Door with Standard L-Frame \_\_\_\_\_ Enter actual "A" measurement or 1<sup>5</sup>/<sub>8</sub>", whichever is **less**.
- French Door with Trim L-Frame \_\_\_\_\_
- French Door with Hang Strips (FD) \_\_\_\_\_ Enter actual "A" measurement or 1<sup>3</sup>/<sub>8</sub>", whichever is **less**.
- French Door Cut-Out (FDC) \_\_\_\_\_

Sidemark

Line Number

Page Number

FDC measuring tool must be used to ensure handle rotation

1. Determine the ordered width.

$$\boxed{\phantom{000}} + \boxed{\phantom{000}} + \boxed{\phantom{000}} = \boxed{\phantom{000}}$$

B                      A                      A                      Ordered Width

2. Determine the ordered height.

$$\boxed{\phantom{000}} + \boxed{\phantom{000}} + \boxed{\phantom{000}} = \boxed{\phantom{000}}$$

C                      A                      A                      Ordered Height

3. Determine divider rail location (if French Door Cut-Out, see ordering note #3).

$$\boxed{\phantom{000}} + \boxed{\phantom{000}} = \boxed{\phantom{000}}$$

D                      A                      Divider Rail Location

4. For French Door Cut-Outs: Determine the cut-out location (see ordering note #4).

$$\boxed{\phantom{000}} + \boxed{\phantom{000}} = \boxed{\phantom{000}}$$

E                      A                      French Door Cut-Out Location

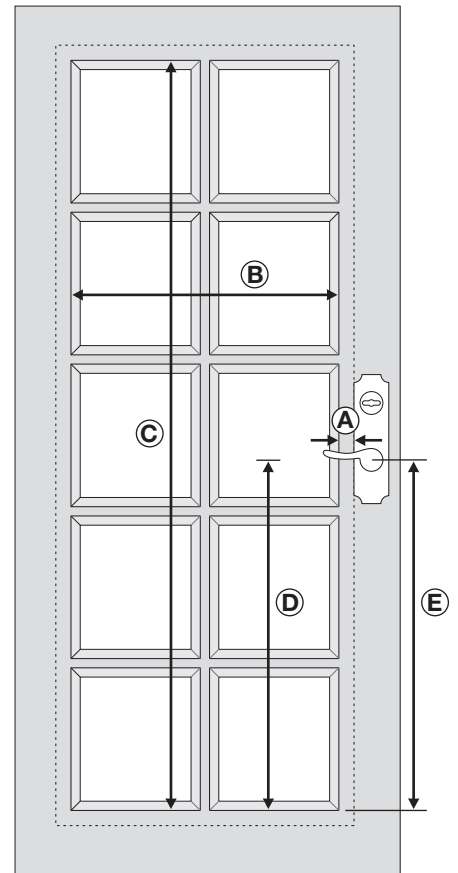

5. **Side-by-side companion door(s) without cut-out:** In some cases, there may be side-by-side companion door(s) that do not require a cut-out. If this is the case, please mark "Yes" below to ensure heights are the same:

Companion Door? YES  NO  If "Yes", please indicate line #:  page #:

### Ordering Notes

- Transfer final dimensions to your shutter order form.
- Attach a copy of this worksheet to the order form.
- If using a divider rail with French Door Cut-Outs, **D** and **E** may be the same or otherwise refer to the Reference Guide for the proper divider rail location.
- To ensure exact cut-out locations, the height may increase up to 1" with 2<sup>1</sup>/<sub>2</sub>" louvers and up to 2" with 3<sup>1</sup>/<sub>2</sub>" louvers. Be sure there is enough room at the top and bottom of the door to accommodate this possible increase.

### Worksheet Key

- A** = Distance between the handle baseplate to glass/molding; enter actual dimension or 1<sup>3</sup>/<sub>8</sub>" (1<sup>5</sup>/<sub>8</sub>" with Standard L-Frame), whichever is **less** (minimum distance is 1<sup>1</sup>/<sub>2</sub>").
- B** = Outside glass/molding measurement width.
- C** = Outside glass/molding measurement height.
- D** = Outside glass/molding measurement to divider rail location.
- E** = Outside glass/molding measurement to center of handle (French Door Cut-Outs only).