

Duette® Honeycomb Shades

ULTIMATE FABRIC VARIETY

The collection with the most honeycomb constructions, opacities, colors, textures, prints and applications.

- 3/8", 3/4" and 1 1/4" pleat sizes
- Architella®, single, double and triple honeycomb fabrics
- Sheer, semi-sheer, semi-opaque and opaque fabrics
- Elegant woven and textured fabrics

THE MOST APPLICATIONS

Duette® with Cordlock (DU-46)

Duette with UltraGlide® (DU-47)

Cordlock and UltraGlide shades are available with these design options:

- Standard
- Top-Down
- Top-Down/Bottom-Up
- Duolite™
- Two-On-One Headrail

Duette with LiteRise® (DU-48)

- Standard
- Top-Down/Bottom-Up
- Duolite
- TrimKit

Duette with TruRise® (DU-49)

Duette with EasyRise™ (DU-50)

- Standard
- Top-Down/Bottom-Up
- Duolite
- Two-On-One Headrail

Duette with Vertiglide™ (DU-51)

- Standard
- Duolite

Sidelights (DU-52)

- Non-Operable
- Cordless Operable

Duette with Simplicity™ (DU-53)

Duette with Skyrise® (DU-54)

Duette with EasyView® Arch (DU-55)

Arches, Circles, Angles and Specialty Shapes (DU-56 to DU-58)

Duette PowerRise® with Platinum™ Technology

- Standard (DU-59)
- Top-Down (DU-59)
- Skylight (DU-60)

Duette with Hard-Wired Motorization

- Skyrise (DU-63)
- Hard-Wired Motorization (DU-64)

Cut-Outs (DU-66)

CONTENTS

Size StandardsDU-2
 PricingDU-16
 Product Specifications.....DU-46
 Stacking Heights.....DU-67

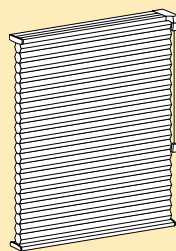

Duette With Cordlock
DU-46

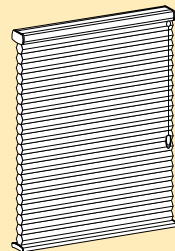

Duette With UltraGlide
DU-47

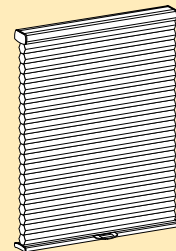

Duette With LiteRise
DU-48

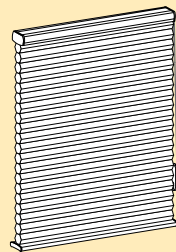

Duette With EasyRise
DU-50

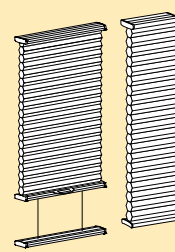

Sidelights
DU-52

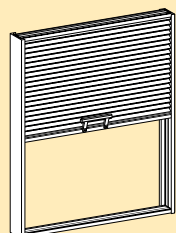

Duette With Simplicity
DU-53

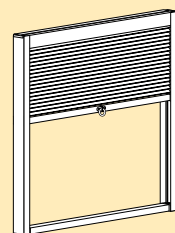

Duette With Skyrise
DU-54

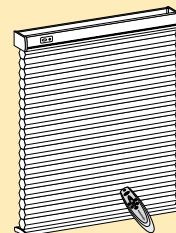

Duette With PowerRise
DU-59 To DU-62

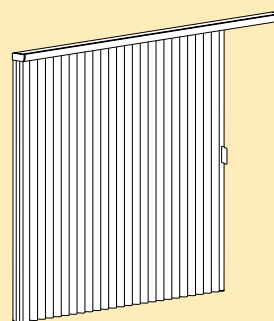

Duette With Vertiglide
DU-51

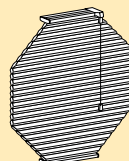

Arches, Circles,
Angles And
Specialty Shapes
DU-56 To DU-58

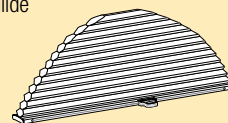

Duette With
EasyView Arch
DU-55

Size Standards: Cordlock and UltraGlide®

DUETTE® HONEYCOMB SHADES

HOW TO USE THE SIZE STANDARDS CHART

The Size Standards charts are designed to be a quick reference to size standards, price charts and where to find further product specifications. Price charts are referenced by chart number next to the fabric style and further product specifications are referenced by page number under the application. Additional information that may be needed is bulleted at the bottom of each chart. **Important: shade dimensions must be equal to or less than the maximum dimensions (width, height and area) and equal to or greater than the minimum dimensions (width and height) to be within specification guidelines.**

SIZE STANDARDS	Cordlock Standard DU-46	Cordlock Top-Down DU-46	Cordlock Top-Down/ Bottom-Up DU-46	Cordlock Duolite™ DU-46	Cordlock Two-On-One Headrail DU-46	UltraGlide® Standard DU-47	UltraGlide Top-Down DU-47	UltraGlide Top-Down/ Bottom-Up DU-47	UltraGlide Duolite DU-47	UltraGlide Two-On-One Headrail DU-47
C20 ARCHITELLA® PANACHE™ ¾" SEMI-OPAQUE (Price Chart A4)										
C22 ARCHITELLA ELAN™ ¾" SEMI-OPAQUE (Price Chart A4)										
Width:	174"	108"	108"	—	174"	144"	144"	120"	72"	174"
Height:	120"	120"	108"	—	120"	144"	144"	144"	144"	144"
Area (sq. ft.):	60	60	40	—	60/panel	90	90	50	50/panel	90/panel
C21 ARCHITELLA PANACHE ECLIPSE™ ¾" OPAQUE (Price Chart A8)										
C23 ARCHITELLA ELAN ECLIPSE™ ¾" OPAQUE (Price Chart A8)										
Width:	174"	108"	108"	—	174"	144"	144"	120"	72"	174"
Height:	120"	120"	108"	—	120"	132"	132"	132"	132"	132"
Area (sq. ft.):	60	60	40	—	60/panel	65	65	50	40/panel	65/panel
C40 ARCHITELLA PANACHE 1¼" SEMI-OPAQUE (Price Chart A14)										
C42 ARCHITELLA ELAN 1¼" SEMI-OPAQUE (Price Chart A14)										
Width:	—	—	—	—	—	144"	144"	120"	72"	174"
Height:	—	—	—	—	—	144"	144"	144"	144"	144"
Area (sq. ft.):	—	—	—	—	—	70	70	40	40/panel	70/panel
C41 ARCHITELLA PANACHE ECLIPSE 1¼" OPAQUE (Price Chart A15)										
C43 ARCHITELLA ELAN ECLIPSE 1¼" OPAQUE (Price Chart A15)										
Width:	—	—	—	—	—	144"	144"	120"	72"	174"
Height:	—	—	—	—	—	144"	144"	144"	144"	144"
Area (sq. ft.):	—	—	—	—	—	70	70	40	40/panel	70/panel
C50 ARCHITELLA CLASSIC ¾" SEMI-OPAQUE (Price Chart A4)										
Width:	174"	174"	108"	—	174"	144"	144"	120"	72"	174"
Height:	154"	154"	144"	—	154"	144"	144"	144"	144"	144"
Area (sq. ft.):	40	40	30	—	40/panel	100	100	60	40/panel	100/panel
C51 ARCHITELLA CLASSIC ECLIPSE™ ¾" OPAQUE (Price Chart A8)										
Width:	174"	174"	108"	—	174"	144"	144"	120"	72"	174"
Height:	147"	147"	144"	—	147"	144"	144"	144"	144"	144"
Area (sq. ft.):	40	40	30	—	40/panel	80	80	50	40/panel	80/panel
C70 ARCHITELLA CLASSIC 1¼" SEMI-OPAQUE (Price Chart A14)										
Width:	—	—	—	—	—	144"	144"	120"	72"	174"
Height:	—	—	—	—	—	144"	144"	144"	144"	144"
Area (sq. ft.):	—	—	—	—	—	90	90	50	40/panel	90/panel
C71 ARCHITELLA CLASSIC ECLIPSE 1¼" OPAQUE (Price Chart A15)										
Width:	—	—	—	—	—	144"	144"	120"	72"	174"
Height:	—	—	—	—	—	144"	144"	144"	144"	144"
Area (sq. ft.):	—	—	—	—	—	70	70	40	40/panel	70/panel
MINIMUMS										
Width:	8"	8"	12"	—	8"/panel	12"	12"	18"	18"	12"/panel
Height:	6"	6"	6"	—	6"	6"	6"	6"	6"	6"

Size Standards: LiteRise®, TruRise® and EasyRise™

DUETTE® HONEYCOMB SHADES

Duette

SIZE STANDARDS	LiteRise® Standard DU-48	LiteRise Top-Down/ Bottom-Up DU-48	LiteRise Duolite™ DU-48	TruRise® Standard DU-49	EasyRise™ Standard DU-50	EasyRise Top-Down/ Bottom-Up DU-50	EasyRise Duolite DU-50	EasyRise Two-On-One Headrail DU-50
C20 ARCHITELLA® PANACHE™ 3/4" SEMI-OPAQUE (Price Chart A4)								
C22 ARCHITELLA ELAN™ 3/4" SEMI-OPAQUE (Price Chart A4)								
Width:	120"	120"	72"	—	174"	174"	174"	174"
Height:	84"	84"	84"	—	144"	144"	144"	144"
Area (sq. ft.):	70	70	42/panel	—	100	100	60/panel	100/panel
C21 ARCHITELLA PANACHE ECLIPSE™ 3/4" OPAQUE (Price Chart A8)								
C23 ARCHITELLA ELAN ECLIPSE™ 3/4" OPAQUE (Price Chart A8)								
Width:	120"	120"	72"	—	174"	174"	174"	174"
Height:	84"	84"	84"	—	132"	132"	132"	132"
Area (sq. ft.):	70	70	42/panel	—	90	90	60/panel	90/panel
C40 ARCHITELLA PANACHE 1 1/4" SEMI-OPAQUE (Price Chart A14)								
C42 ARCHITELLA ELAN 1 1/4" SEMI-OPAQUE (Price Chart A14)								
Width:	120"	120"	72"	120"	174"	174"	174"	174"
Height:	84"	84"	84"	84"	144"	144"	144"	144"
Area (sq. ft.):	70	70	42/panel	40	100	100	60/panel	100/panel
C41 ARCHITELLA PANACHE ECLIPSE 1 1/4" OPAQUE (Price Chart A15)								
C43 ARCHITELLA ELAN ECLIPSE 1 1/4" OPAQUE (Price Chart A15)								
Width:	120"	120"	72"	120"	174"	174"	174"	174"
Height:	84"	84"	84"	84"	144"	144"	144"	144"
Area (sq. ft.):	70	70	42/panel	40	90	90	60/panel	90/panel
C50 ARCHITELLA CLASSIC 3/4" SEMI-OPAQUE (Price Chart A4)								
Width:	120"	120"	72"	—	174"	174"	174"	174"
Height:	84"	84"	84"	—	144"	144"	144"	144"
Area (sq. ft.):	70	70	42/panel	—	120	120	60/panel	120/panel
C51 ARCHITELLA CLASSIC ECLIPSE™ 3/4" OPAQUE (Price Chart A8)								
Width:	120"	120"	72"	—	174"	174"	174"	174"
Height:	84"	84"	84"	—	144"	144"	144"	144"
Area (sq. ft.):	70	70	42/panel	—	110	110	60/panel	110/panel
C70 ARCHITELLA CLASSIC 1 1/4" SEMI-OPAQUE (Price Chart A14)								
Width:	120"	120"	72"	120"	174"	174"	174"	174"
Height:	84"	84"	84"	84"	144"	144"	144"	144"
Area (sq. ft.):	70	70	42/panel	30	110	110	60/panel	110/panel
C71 ARCHITELLA CLASSIC ECLIPSE 1 1/4" OPAQUE (Price Chart A15)								
Width:	120"	120"	72"	120"	174"	174"	174"	174"
Height:	84"	84"	84"	84"	144"	144"	144"	144"
Area (sq. ft.):	70	70	42/panel	30	110	110	60/panel	110/panel
MINIMUMS								
Width:	18"	20"	20"	18"	12"	24"	24"	12"/panel
Height:	6"	6"	6"	12"	24"	24"	24"	24"

Size Standards: LiteRise®, TruRise® and EasyRise™

DUETTE® HONEYCOMB SHADES

SIZE STANDARDS	LiteRise® Standard DU-48	LiteRise Top-Down/ Bottom-Up DU-48	LiteRise Duolite™ DU-48	TruRise® Standard DU-49	EasyRise™ Standard DU-50	EasyRise Top-Down/ Bottom-Up DU-50	EasyRise Duolite DU-50	EasyRise Two-On-One Headrail DU-50
D1 CLASSIC 3/8" SEMI-OPAQUE (Price Chart A1)								
Width:	120"	120"	—	—	174"	174"	174"	174"
Height:	84"	84"	—	—	144"	144"	144"	144"
Area (sq. ft.):	70	70	—	—	150	150	120/panel	150/panel
D2 CLASSIC 3/4" SEMI-OPAQUE (Price Chart A2)								
Width:	120"	120"	72"	—	174"	174"	174"	174"
Height:	84"	84"	84"	—	144"	144"	144"	144"
Area (sq. ft.):	70	70	42/panel	—	150	150	80/panel	150/panel
D6 EXPRESSIONS™ 3/4" SEMI-SHEER (Price Chart A5)								
Width:	120"	120"	72"	—	174"	174"	174"	174"
Height:	84"	84"	84"	—	144"	144"	144"	144"
Area (sq. ft.):	70	70	42/panel	—	150	150	100/panel	150/panel
D7 CLASSIC ECLIPSE™ 3/4" OPAQUE (Price Chart A6)								
Width:	120"	120"	72"	—	174"	174"	174"	174"
Height:	84"	84"	84"	—	144"	144"	144"	144"
Area (sq. ft.):	70	70	42/panel	—	100	100	80/panel	100/panel
D8, D9 WHISPER™ 3/4" SHEER (Price Chart A5)								
Width:	120"	120"	72"	—	174"	174"	174"	174"
Height:	84"	84"	84"	—	144"	144"	144"	144"
Area (sq. ft.):	70	70	42/panel	—	150	150	100/panel	150/panel
D10 CLASSIC 1 1/4" SEMI-OPAQUE (Price Chart A11)								
Width:	120"	120"	72"	120"	174"	174"	174"	174"
Height:	84"	84"	84"	84"	144"	144"	144"	144"
Area (sq. ft.):	70	70	42/panel	50	150	150	100/panel	150/panel
D12 CLASSIC ECLIPSE 1 1/4" OPAQUE (Price Chart A13)								
Width:	120"	120"	72"	120"	174"	174"	174"	174"
Height:	84"	84"	84"	84"	144"	144"	144"	144"
Area (sq. ft.):	70	70	42/panel	50	150	150	100/panel	150/panel
D13, D14, D15 OPALESCENCE™ 3/4" SEMI-OPAQUE (Price Chart A3)								
Width:	120"	120"	72"	—	174"	174"	174"	174"
Height:	84"	84"	84"	—	144"	144"	144"	144"
Area (sq. ft.):	70	70	42/panel	—	150	150	80/panel	150/panel
D16 COMMERCIAL 3/4" OPAQUE (Price Chart A7)								
Width:	120"	—	—	—	174"	174"	174"	174"
Height:	84"	—	—	—	144"	144"	144"	144"
Area (sq. ft.):	70	—	—	—	120	120	60/panel	120/panel
D17 BATISTE REFINED™ 3/4" SEMI-OPAQUE (Price Chart A6)								
D19 BATISTE TEXTURED™ 3/4" SEMI-OPAQUE (Price Chart A6)								
Width:	120"	120"	72"	—	174"	174"	174"	174"
Height:	84"	84"	84"	—	144"	144"	144"	144"
Area (sq. ft.):	70	70	42/panel	—	150	150	80/panel	150/panel
D20 COMMERCIAL 3/4" SEMI-OPAQUE (Price Chart A2)								
Width:	120"	—	—	—	174"	174"	174"	174"
Height:	84"	—	—	—	144"	144"	144"	144"
Area (sq. ft.):	70	—	—	—	150	150	60/panel	150/panel
D21 COMMERCIAL 3/8" SEMI-OPAQUE (Price Chart A2)								
Width:	—	—	—	—	174"	174"	174"	174"
Height:	—	—	—	—	138"	138"	138"	138"
Area (sq. ft.):	—	—	—	—	130	130	80/panel	130/panel
D36 BATISTE TEXTURED 1 1/4" SEMI-OPAQUE (Price Chart A13)								
Width:	120"	120"	72"	120"	174"	174"	174"	174"
Height:	84"	84"	84"	84"	144"	144"	144"	144"
Area (sq. ft.):	70	70	42/panel	37	130	130	80/panel	130/panel
D40, D49 WHISPER 1 1/4" SHEER (Price Chart A12)								
Width:	120"	120"	72"	120"	174"	174"	174"	174"
Height:	84"	84"	84"	84"	144"	144"	144"	144"
Area (sq. ft.):	70	70	42/panel	70	150	150	100/panel	150/panel
MINIMUMS								
Width:	18"	20"	20"	18"	12"	24"	24"	12"/panel
Height:	6"	6"	6"	12"	24"	24"	24"	24"

Size Standards: LiteRise®, TruRise® and EasyRise™

DUETTE® HONEYCOMB SHADES

Duette

SIZE STANDARDS	LiteRise® Standard DU-48	LiteRise Top-Down/ Bottom-Up DU-48	LiteRise Duolite™ DU-48	TruRise® Standard DU-49	EasyRise™ Standard DU-50	EasyRise Top-Down/ Bottom-Up DU-50	EasyRise Duolite DU-50	EasyRise Two-On-One Headrail DU-50
G1 PHENOMENA™ TRIPLE HONEYCOMB (Price Chart A5)								
Width:	—	—	—	—	174"	174"	174"	174"
Height:	—	—	—	—	144"	144"	144"	144"
Area (sq. ft.):	—	—	—	—	115	115	60/panel	115/panel
G2 ROYALE TEXTURED™ 3/4" SEMI-OPAQUE (Price Chart A9)								
Width:	120"	120"	72"	—	174"	174"	174"	174"
Height:	84"	84"	84"	—	144"	144"	144"	144"
Area (sq. ft.):	70	70	42/panel	—	130	130	60/panel	130/panel
G3 ROYALE REFINED™ 3/4" SEMI-OPAQUE (Price Chart A9)								
Width:	120"	120"	72"	—	174"	174"	174"	174"
Height:	84"	84"	84"	—	144"	144"	144"	144"
Area (sq. ft.):	70	70	42/panel	—	130	130	60/panel	130/panel
G4 ROYALE REFINED ECLIPSE™ 3/4" OPAQUE (Price Chart A10)								
Width:	120"	120"	72"	—	174"	174"	174"	174"
Height:	84"	84"	84"	—	144"	144"	144"	144"
Area (sq. ft.):	70	70	42/panel	—	110	110	60/panel	110/panel
G5 ENCORE™ DOUBLE HONEYCOMB (Price Chart A3)								
Width:	120"	—	—	—	174"	174"	174"	174"
Height:	84"	—	—	—	144"	144"	144"	144"
Area (sq. ft.):	70	—	—	—	150	150	80/panel	150/panel
G9 PANACHE™ 3/4" SEMI-OPAQUE (Price Chart A2)								
Width:	120"	120"	72"	—	174"	174"	174"	174"
Height:	84"	84"	84"	—	144"	144"	144"	144"
Area (sq. ft.):	70	70	42/panel	—	150	150	80/panel	150/panel
G10 PANACHE ENCORE™ DOUBLE HONEYCOMB (Price Chart A3)								
Width:	120"	—	—	—	174"	174"	174"	174"
Height:	84"	—	—	—	144"	144"	144"	144"
Area (sq. ft.):	70	—	—	—	130	130	60/panel	130/panel
G12 PANACHE 3/8" SEMI-OPAQUE (Price Chart A1)								
Width:	120"	120"	—	—	174"	174"	174"	174"
Height:	84"	84"	—	—	144"	144"	144"	144"
Area (sq. ft.):	70	70	—	—	150	150	120/panel	150/panel
G23, G24, G25 OPALESCENCE ECLIPSE™ 3/4" OPAQUE (Price Chart A7)								
Width:	120"	120"	72"	—	174"	174"	174"	174"
Height:	84"	84"	84"	—	144"	144"	144"	144"
Area (sq. ft.):	70	70	42/panel	—	150	150	60/panel	150/panel
H7 CLASSIC ECLIPSE™ 3/8" OPAQUE (Price Chart A6)								
Width:	—	—	—	—	174"	174"	174"	174"
Height:	—	—	—	—	144"	144"	144"	144"
Area (sq. ft.):	—	—	—	—	150	150	80/panel	150/panel
H20 ARIOSIA™ 3/4" SEMI-OPAQUE (Price Chart A3)								
Width:	120"	120"	—	—	174"	174"	174"	174"
Height:	84"	84"	—	—	144"	144"	144"	144"
Area (sq. ft.):	70	70	—	—	150	150	80/panel	150/panel
Y20-Y31 ARCHITELLA® MERITAGE™ 3/4" SEMI-OPAQUE (Price Chart A10)								
Width:	120"	120"	72"	—	174"	174"	174"	174"
Height:	84"	84"	84"	—	138"	138"	138"	138"
Area (sq. ft.):	60	60	42/panel	—	60	60	40/panel	60/panel
MINIMUMS								
Width:	18"	20"	20"	18"	12"	24"	24"	12"/panel
Height:	6"	6"	6"	12"	24"	24"	24"	24"

Notes for pages DU-5 to DU-7:

- Maximum width for end-mounted shades is 36".
- Duolite shades: opaque fabric is available on bottom panel only.
- Duolite shades: use the smaller of the two maximum areas for the maximum area per panel.

Pricing

DUETTE® HONEYCOMB SHADES

Product price only, not including freight, state/local taxes, measuring and installation, and other services associated with a custom installation.

DUETTE® A5		Cordlock Standard																	▶ Expressions™ 3/4" Semi-Sheer (D6) ▶ Whisper™ 3/4" Sheer (D8, D9) ▶ Phenomena™ Triple Honeycomb (G1)		
WIDTH TO:		24"	30"	36"	42"	48"	54"	60"	66"	72"	84"	96"	108"	120"	132"	144"	156"	174"			
36"		\$227	253	290	321	355	392	424	459	496	572	651	728	807	886	965	1041	1154			
42"		240	275	312	350	389	427	465	507	547	631	717	801	891	979	1071	1155	1278			
48"		253	293	333	378	420	462	505	551	595	688	782	875	972	1071	1167	1263	1398			
54"		268	313	357	403	454	498	545	594	645	744	847	948	1053	1162	1268	1371	1520			
60"		290	331	382	434	486	535	582	638	693	804	918	1028	1142	1256	1369	1484	1651			
66"		307	352	404	460	515	570	621	682	741	859	981	1100	1221	1343	1467	1589	1771			
72"		319	367	431	490	548	610	665	729	793	917	1051	1179	1309	1441	1572	1704	1894			
78"		335	386	453	518	577	642	703	774	838	973	1113	1250	1389	1530	1668	1808	2009			
84"		344	404	472	539	606	672	735	810	879	1017	1162	1307	1458	1603	1748	1896	2112			
90"		362	426	495	564	636	705	777	853	924	1075	1229	1381	1538	1692	1850	2007	2230			
96"		373	440	515	591	666	739	810	885	962	1122	1281	1442	1605	1768	1931	2094	2327			
102"		385	460	539	616	696	772	848	933	1015	1174	1342	1514	1680	1853	2024	2195	2447			
108"		401	474	560	638	722	804	885	971	1056	1227	1401	1576	1754	1932	2108	2284	2556			
114"		416	491	579	663	749	838	923	1014	1102	1280	1461	1647	1828	2018	2195	2394	2673			
120"		430	512	601	692	782	868	958	1052	1140	1328	1518	1707	1900	2096	2293	2488	2774			
132"		455	549	645	743	843	937	1035	1135	1233	1432	1639	1844	2051	2261	2474	2681	2993			
144"		484	581	684	790	892	999	1104	1208	1312	1530	1745	1965	2184	2410	2633	2854	3244			

Note: Refer to the Size Standards on pages DU-2 to DU-15 for individual size specifications.

Lifting System Upgrade Surcharges (Add to Cordlock Standard base price.)

WIDTH TO:	24"	30"	36"	42"	48"	54"	60"	66"	72"	84"	96"	108"	120"	132"	144"	156"	174"
ULTRAGLIDE®	\$63	66	69	73	77	82	87	92	98	104	110	117	124	131	139		
LITERISE®	63	66	69	73	77	82	87	92	98	104	110	117	124				
POWERRISE®	206	211	217	224	234	245	257	266	277	286	291	307	312	317	323	330	
POWERRISE SKYLIGHT	629	634	640	647	657	668	680	689	700								
EASYRISE™	63	66	69	73	77	82	87	92	98	104	110	117	124	131	139	147	156

Design Options Surcharges (Add surcharge to base price.)

For Further Info
See Page(s)

CORDLESS OPERABLE SIDELIGHTS	Add \$31 to price shown in 24" width column	DU-52
NON-OPERABLE SIDELIGHTS	Subtract 50% from the price shown in the 24" width column	DU-52
TOP-DOWN AND TOP-DOWN/BOTTOM-UP	Add \$99	DU-46 to DU-48, DU-50, DU-58 and DU-59
DUOLITE™	Price each fabric as a separate shade and add together	DU-46 to DU-48 and DU-50
TWO-ON-ONE HEADRAIL	Price as two separate shades and add together	DU-46 and DU-47, DU-50
EXTENSION POLE	Add \$73 (51" or 120" available; specify on order form)	DU-48, DU-53 and DU-54
LITERISE TRIMKIT	Add \$199	DU-48
ANGLES AND SPECIALTY SHAPES	Price using overall measurements and add \$184	DU-57 and DU-58
CUT-OUTS	Add \$78 per side	DU-66
POWERRISE WITH PLATINUM™ TECHNOLOGY AND HARD-WIRED MOTORIZATION SURCHARGES	See page DU-45	

Cordlock Product Specifications

DUETTE® HONEYCOMB SHADES

APPLICATIONS

- Standard
- Top-Down
- Top-Down/Bottom-Up
- Duolite™
- Two-On-One Headrail
 - Available with either Top-Down or Bottom-Up operation

Size Standards

See Size Standards on pages DU-2 to DU-4

Mounting Requirements

3/8" Pleat

Inside (IB) Mount/End (EB) Mount

Minimum mounting depth:	
Standard installation bracket	1"
Swivel bracket	1/2"

Minimum mounting depth, flush mount:

Standard installation bracket	1 5/8"
Swivel bracket	1 1/4"
End mount bracket	1 1/4"

Outside (OB) Mount

Minimum flat vertical surface:	
Standard installation bracket	5/8"

3/4" Pleat, Double and Triple Honeycomb

Inside (IB) Mount

Minimum mounting depth:	
Standard installation bracket	1 1/4"
Swivel bracket	1/2"

Minimum mounting depth, flush mount:

Standard installation bracket	2 3/8"
Swivel bracket	2"
End mount bracket	2"

Outside (OB) Mount

Minimum flat vertical surface:	
Standard installation bracket	1"

Notes:

- Cordlock cover will add an additional 3/4" of depth at operable end(s) of headrail.
- For headrail dimensions, please refer to the General Information section — Measuring Guidelines of this Reference Guide.

Finished Dimensions

(All allowances are taken from ordered dimensions and may vary slightly.)

Inside (IB) Mount

Headrail unit	-3/16"
Shade height	ordered height
Fabric width	-3/8"

Outside (OB) Mount

Headrail unit	ordered width
Shade height	ordered height
Fabric width	-3/16"

End (EB) Mount

Headrail unit	-3/16"
Shade height	ordered height
Fabric width	-3/8"

Two-On-One Headrail

Gap between fabric panels	-1/4"
---------------------------	-------

Hardware Included

Installation brackets

Optional Features

No Charge — Specify on Order

Swivel brackets (inside mounts only)

End mount brackets

Spacer blocks

Extension brackets

Hold-down brackets

Cord Length

Surcharge — Specify on Order

Cut-outs (standard only; see page DU-66)

HOW TO PRICE

- **Important Note!** All base prices are predicated on Ordered Dimensions, not Finished Dimensions.
- Base prices shown on price charts A1 to A10 (see pages DU-16 to DU-25).
- With Duolite and Two-On-One Headrail shades, price each fabric panel as a separate Cordlock shade and add together.
- Add any applicable surcharges shown below price chart for Top-Down and Top-Down/Bottom-Up shades.

EXCLUSIONS

- 1 1/4" pleat fabrics
- Two-On-One Headrail as end (EB) mounts
- Two-On-One Headrail with hold-down brackets
- Top-Down/Bottom-Up with Two-On-One Headrail
- Duolite with Two-On-One Headrail
- Ariosia™ 3/4" semi-opaque fabric with Two-On-One Headrail
- Ariosia 3/4" semi-opaque fabric with Duolite option

ORDERING CHECKLIST

- ✓ Specify inside (IB), outside (OB) or end (EB) mount.
- ✓ Standard and Top-Down only: specify left- or right-side lift cord.
- ✓ Specify optional mounting hardware or other optional features.

Duolite Only

- ✓ On the order form, list top fabric panel first and bottom fabric panel second.
- ✓ Different pleat sizes cannot be combined on the same shade.
- ✓ Double honeycomb and Phenomena triple honeycomb fabrics may be used in combination with any 3/4" pleat size.
- ✓ Opaque fabric can be used on bottom panel only.
- ✓ All hardware will coordinate with the bottom panel fabric selection.

APPLICATIONS

- Standard
- Top-Down
- Top-Down/Bottom-Up
- Duolite™
- Two-On-One Headrail
 - Available with either Top-Down or Bottom-Up operation
- All applications include color-coordinated, fabric-covered valance

Note: To operate Duolite and Top-Down/Bottom-Up shades, the right cord operates the center rail and the left cord operates the bottom rail. "Reverse Controls" are not available.

Size Standards

See Size Standards on pages DU-2 to DU-4

Mounting Requirements

3/8" Pleat

Inside (IB) Mount/End (EB) Mount

Minimum mounting depth, inside mount	1/2"
Minimum mounting depth, end mount	1 1/4"
Minimum mounting depth, flush mount	2 1/4"

Outside (OB) Mount

Minimum flat vertical surface	1 1/4"
-------------------------------	--------

3/4" Pleat, Double and Triple Honeycomb

Inside (IB) Mount/End (EB) Mount

Minimum mounting depth, inside mount	1/2"
Minimum mounting depth, end mount	1 1/4"
Minimum mounting depth, flush mount	2 7/8"

Outside (OB) Mount

Minimum flat vertical surface	1 1/4"
-------------------------------	--------

1 1/4" Pleat

Inside (IB) Mount/End (EB) Mount

Minimum mounting depth, inside mount	1/2"
Minimum mounting depth, end mount	1 1/4"
Minimum mounting depth, flush mount	3 5/8"

Outside (OB) Mount

Minimum flat vertical surface	1 1/4"
-------------------------------	--------

Note: For headrail dimensions please refer to the General Information section — Measuring Guidelines of this Reference Guide.

Finished Dimensions

(All allowances are taken from ordered dimensions and may vary slightly.)

Inside (IB) Mount

Headrail unit	-3/16"
Shade height	ordered height
Fabric width	-3/8"

Outside (OB) Mount

Headrail unit	ordered width
Shade height	ordered height
Fabric width	-3/16"

End (EB) Mount

Headrail unit	-11/16"
Shade height	ordered height
Fabric width	-7/8"

Two-On-One Headrail

Gap between fabric panels	1/4"
---------------------------	------

Hardware Included

Installation brackets

Optional Features

No Charge — Specify on Order

Spacer blocks
Extension brackets (required for end mounts)
Hold-down brackets

Surcharge — Specify on Order

Cut-outs (standard only; see page DU-66)

HARDWARE COLORS

- Bottom and center rail (if applicable) will coordinate to shade fabric (except 1 1/4" fabrics).

HOW TO PRICE

- **Important Note!** All base prices are predicated on Ordered Dimensions, not Finished Dimensions.
- Add width-based Duette with UltraGlide® surcharge to Cordlock or TruRise® Standard base price shown on charts A1 to A15 (see pages DU-16 to DU-30).
- With Duolite and Two-On-One Headrail shades, price each fabric panel as a separate shade and add together.
- Add any applicable surcharges shown below price chart for Top-Down and Top-Down/Bottom-Up shades.

EXCLUSIONS

- Commercial fabric
- Two-On-One Headrail shades as end (EB) mounts
- Two-On-One Headrail shades with hold-down brackets
- Top-Down/Bottom-Up with Two-On-One Headrail shades
- Duolite with Two-On-One Headrail shades
- End (EB) mount shades over 36" wide

ORDERING CHECKLIST

- ✓ Specify inside (IB), outside (OB) or end (EB) mount. Order extension brackets for end mount applications.
- ✓ Standard and Top-Down only: specify left- or right-side lift cord.
- ✓ Specify optional mounting hardware or other optional features.

Duolite Only

- ✓ On the order form, list top fabric panel first and bottom fabric panel second.
- ✓ Different pleat sizes cannot be combined on the same shade.
- ✓ Double and triple honeycomb fabrics may only be used in combination with 3/4" pleat fabrics.
- ✓ Opaque fabric can be used on bottom panel only.
- ✓ All hardware will coordinate with the bottom panel fabric selection.

LiteRise® Product Specifications

DUETTE® HONEYCOMB SHADES

APPLICATIONS

- Standard
- Top-Down/Bottom-Up
- Duolite™
- All applications include color-coordinated, fabric-covered valance

Size Standards

See Size Standards on pages DU-5 to DU-7

Mounting Requirements

3/8" Pleat

Inside (IB) Mount/End (EB) Mount

Minimum mounting depth, inside mount	1/2"
--------------------------------------	------

Minimum mounting depth, end mount	1 1/4"
-----------------------------------	--------

Minimum mounting depth, flush mount	2 1/4"
-------------------------------------	--------

Outside (OB) Mount

Minimum flat vertical surface	1 1/4"
-------------------------------	--------

3/4" Pleat and Double Honeycomb

Inside (IB) Mount/End (EB) Mount

Minimum mounting depth, inside mount	1/2"
--------------------------------------	------

Minimum mounting depth, end mount	1 1/4"
-----------------------------------	--------

Minimum mounting depth, flush mount	2 7/8"
-------------------------------------	--------

Outside (OB) Mount

Minimum flat vertical surface	1 1/4"
-------------------------------	--------

1 1/4" Pleat

Inside (IB) Mount/End (EB) Mount

Minimum mounting depth, inside mount	1/2"
--------------------------------------	------

Minimum mounting depth, end mount	1 1/4"
-----------------------------------	--------

Minimum mounting depth, flush mount	3 5/8"
-------------------------------------	--------

Outside (OB) Mount

Minimum flat vertical surface	1 1/4"
-------------------------------	--------

Note: For headrail dimensions please refer to the General Information section — Measuring Guidelines of this Reference Guide.

Finished Dimensions

(All allowances are taken from ordered dimensions and may vary slightly.)

Inside (IB) Mount

Headrail unit	-3/16"
---------------	--------

Shade height	ordered height
--------------	----------------

Fabric width	-3/8"
--------------	-------

Outside (OB) Mount

Headrail unit	ordered width
---------------	---------------

Shade height	ordered height
--------------	----------------

Fabric width	-3/16"
--------------	--------

End (EB) Mount

Headrail unit	-1 1/16"
---------------	----------

Shade height	ordered height
--------------	----------------

Fabric width	-7/8"
--------------	-------

Two-On-One Headrail

Gap between fabric panels	1/4"
---------------------------	------

Hardware Included

Installation brackets

Optional Features

No Charge — Specify on Order

Spacer blocks

Extension brackets (required for end mounts)

Hold-down brackets

Surcharge — Specify on Order

LiteRise® TrimKit

LITERISE TRIMKIT

- Available on 3/4" single honeycomb fabrics only.
- Available on inside (IB) mount with the LiteRise system only.
- **Minimum mounting depth is 1 5/8".**
- Available in white only.
- Minimum and maximum specifications will match the fabric selection.
- Add \$199 surcharge to a LiteRise shade.

HARDWARE COLORS

- Bottom and center rail (if applicable) will coordinate to shade fabric (except 1 1/4" fabrics).
- **LiteRise handle will be color coordinated to fabric.**

HOW TO PRICE

- **Important Note!** All base prices are predicated on Ordered Dimensions, not Finished Dimensions.
- Add width-based Duette® with LiteRise surcharge to Cordlock or TruRise® Standard base price shown on price charts A1 to A15 (see pages DU-16 to DU-30).
- Add Top-Down/Bottom-Up surcharge, if ordered.
- Duolite: price each panel as a separate LiteRise shade and add together.

EXCLUSIONS

- 3/8" opaque fabrics
- Commercial 3/8" semi-opaque fabric
- Phenomena™ triple honeycomb fabric
- Double honeycomb on Top-Down/Bottom-Up or Duolite
- Commercial fabrics on Top-Down/Bottom-Up or Duolite option
- 3/8" pleat fabrics on Duolite option
- Ariosa™ fabric on Duolite option
- Cut-outs
- End (EB) mount shades over 36" wide

ORDERING CHECKLIST

- ✓ Specify inside (IB), outside (OB) or end (EB) mount. Order extension brackets for end mount applications.

Duolite Only

- ✓ On the order form, list top fabric panel first and bottom fabric panel second.
- ✓ Different pleat sizes cannot be combined on the same shade.
- ✓ 3/4" pleat fabrics: top panel must be sheer or semi-sheer; bottom panel may be any 3/4" pleat semi-opaque or opaque fabric.
- ✓ 1 1/4" pleat fabrics: top panel must be sheer; bottom panel may be any 1 1/4" pleat semi-opaque or opaque fabric.
- ✓ All hardware will **coordinate with the** bottom panel fabric selection.

APPLICATION

- Standard

Size Standards

See Size Standards on pages DU-5 to DU-7

Mounting Requirements

1 1/4" Pleat

Inside (IB) Mount/End (EB) Mount

Minimum mounting depth, inside mount	1"
Minimum mounting depth, end mount	1 1/4"
Minimum mounting depth, flush mount	3 1/8"

Outside (OB) Mount

Minimum flat vertical surface	5/8"
-------------------------------	------

Note: For headrail dimensions please refer to the General Information section — Measuring Guidelines of this Reference Guide.

Finished Dimensions

(All allowances are taken from ordered dimensions and may vary slightly.)

Inside (IB) Mount/End (EB) Mount

Headrail unit	-3/16"
Shade height	ordered height
Fabric width	-3/8"

Outside (OB) Mount

Headrail unit	ordered width
Shade height	ordered height
Fabric width	-3/16"

Hardware Included

Installation brackets

Optional Features

No Charge — Specify on Order

Spacer blocks
Extension brackets (required for end mounts)
Hold-down brackets

HARDWARE COLORS

- Headrail, bottom rail and tassel colors will complement the fabric selection.

HOW TO PRICE

- **Important Note!** All base prices are predicated on Ordered Dimensions, not Finished Dimensions.
- Base prices shown on price charts A11 to A15 (see pages DU-26 to DU-30).

EXCLUSIONS

- 3/8" pleat fabrics
- 3/4" pleat fabrics
- Double honeycomb fabrics
- Phenomena™ triple honeycomb fabrics
- Cut-outs

ORDERING CHECKLIST

- ✓ Specify inside (IB), outside (OB) or end (EB) mount. Order extension brackets for end mount applications.
- ✓ Specify left- or right-side lift cord.
- ✓ Specify optional mounting hardware.

EasyRise™ Product Specifications

DUETTE® HONEYCOMB SHADES

APPLICATIONS

- Standard
- Top-Down/Bottom-Up
- Duolite™
- Two-On-One Headrail
- All applications include color-coordinated, fabric-covered valance

Note: To operate Duolite and Top-Down/Bottom-Up shades, the right cord operates the center rail and the left cord operates the bottom rail. "Reverse Controls" are not available.

Size Standards

See Size Standards on pages DU-5 to DU-7

Mounting Requirements

3/8" Pleat

Inside (IB) Mount/End (EB) Mount

Minimum mounting depth, inside mount	1/2"
--------------------------------------	------

Minimum mounting depth, end mount	1 1/4"
-----------------------------------	--------

Minimum mounting depth, flush mount	2 1/4"
-------------------------------------	--------

Outside (OB) Mount

Minimum flat vertical surface	1 1/4"
-------------------------------	--------

3/4" Pleat and Double Honeycomb

Inside (IB) Mount/End (EB) Mount

Minimum mounting depth, inside mount	1/2"
--------------------------------------	------

Minimum mounting depth, end mount	1 1/4"
-----------------------------------	--------

Minimum mounting depth, flush mount	2 7/8"
-------------------------------------	--------

Outside (OB) Mount

Minimum flat vertical surface	1 1/4"
-------------------------------	--------

1 1/4" Pleat

Inside (IB) Mount/End (EB) Mount

Minimum mounting depth, inside mount	1/2"
--------------------------------------	------

Minimum mounting depth, end mount	1 1/4"
-----------------------------------	--------

Minimum mounting depth, flush mount	3 5/8"
-------------------------------------	--------

Outside (OB) Mount

Minimum flat vertical surface	1 1/4"
-------------------------------	--------

Note: For headrail dimensions please refer to the General Information section — Measuring Guidelines of this Reference Guide.

Hardware Included

Installation brackets

IMPORTANT

In accordance with the revised American National Standard for Safety of Corded Window Covering Products, EasyRise™ shades require proper mounting of the cord tensioner for the product to function properly. The cord tensioner should not be modified in any way.

Finished Dimensions

(All allowances are taken from ordered dimensions and may vary slightly.)

Inside (IB) Mount

Headrail unit	-3/16"
---------------	--------

Shade height	ordered height
--------------	----------------

Fabric width	-3/8"
--------------	-------

Outside (OB) Mount

Headrail unit	
---------------	--

Standard	+1/2"
----------	-------

Top-Down/Bottom-Up and	
------------------------	--

Two-On-One Headrail	+1"
---------------------	-----

Shade height	ordered height
--------------	----------------

Fabric width	ordered width
--------------	---------------

End (EB) Mount

Headrail unit	-11/16"
---------------	---------

Shade height	ordered height
--------------	----------------

Fabric width	-7/8"
--------------	-------

Two-On-One Headrail

Gap between fabric panels	1/4"
---------------------------	------

Optional Features

No Charge — Specify on Order

Spacer blocks

Extension brackets (required for end mounts)

Hold-down brackets

Cord loop drops

Surcharge — Specify on Order

Cut-outs (see page DU-66)

Cord Loop

Standard Cord Drops — Color Coordinated

Shade height 24" to 39 7/8"	2'
-----------------------------	----

Shade height 40" to 59 7/8"	3'
-----------------------------	----

Shade height 60" to 83 7/8"	4'
-----------------------------	----

Shade height 84" to 107 7/8"	5'
------------------------------	----

Shade height 108" to 144"	Must be specified*
---------------------------	--------------------

Optional Cord Drops — White Only

18" to 12' in 6" increments

12' to 16' in 12" increments

*Cord loops greater than 5' will come in white.

Note: All optional cord loop drops must be specified on order form.

HARDWARE COLORS

- Bottom (and center) rail will coordinate to the shade fabric (except 1 1/4" fabrics).
- Cord tensioner will be color coordinated to fabric.

HOW TO PRICE

- **Important Note!** All base prices are predicated on Ordered Dimensions, not Finished Dimensions.
- Add width-based Duette® with EasyRise surcharge to Cordlock or TruRise® Standard base price shown on charts A1 to A15 (see pages DU-16 to DU-30).
- Add Top-Down/Bottom-Up surcharge, if ordered.
- With Two-On-One Headrail shades, price each fabric panel as a separate EasyRise shade and add together.

EXCLUSIONS

- Two-On-One Headrail shades with hold-down brackets
- End (EB) mount shades over 36" wide
- Two-On-One Headrail with Top-Down/Bottom-Up
- Two-On-One Headrail shades as end (EB) mounts

ORDERING CHECKLIST

- ✓ Specify inside (IB), outside (OB) or end (EB) mount. Order extension brackets for end mount applications.
- ✓ Standard only: specify left- or right-side cord loop.
- ✓ Specify any optional cord loop drops.
- ✓ Specify optional mounting hardware or other optional features.

Duolite Only

- ✓ On the order form, list top fabric panel first and bottom fabric panel second.
- ✓ Different pleat sizes cannot be combined on the same shade.
- ✓ Double and triple honeycomb fabrics may only be used in combination with 3/4" pleat fabrics.
- ✓ Opaque fabric can be used on bottom panel only.
- ✓ All hardware will coordinate with the bottom panel fabric selection.

APPLICATIONS

- Fits sloped (either top or bottom sloping) window openings.
- May be operable or stationary.
- Stationary shades are usually triangles, one angle of which must be 90 degrees.
- If operable, a triangular area at the top of window opening remains covered. Bottom rail will only raise to point where shade begins to narrow.

Size Standards

See Size Standards on pages DU-11 to DU-13

Mounting Requirements

Same as Cordlock Standard shades (see page DU-46)

Finished Dimensions

Finished dimensions vary depending on the degree of the angle. Contact your Hunter Douglas fabricator for specific information.

Note

- Stationary angle specialty shapes may not fully cover the light gap at all corners.

Hardware Included

Installation brackets

Optional Features

No Charge — Specify on Order

Swivel brackets (inside mounts only)

Spacer blocks

Extension brackets

Hold-down brackets

Cord length

HOW TO CALCULATE AREA

- Use inches for calculations.
- Multiply W x H. Divide by 144.
- Multiply W x AH (angle height) x 1/2. Divide by 144.
- Add the two areas.

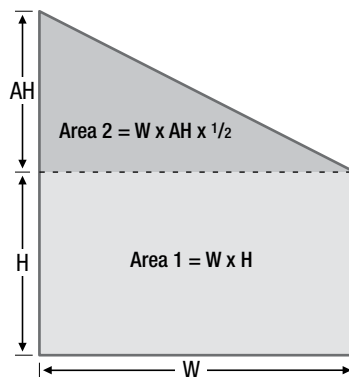

HOW TO PRICE

- **Important Note!** All base prices are predicated on Ordered Dimensions, not Finished Dimensions.
- Add angle surcharge to Cordlock Standard base price (see pages DU-16 to DU-25) using overall shade measurements.

EXCLUSIONS

- 1 1/4" pleat fabrics
- Ariosa™ fabrics
- Double honeycomb and Phenomena™ triple honeycomb fabrics not available in angle bottom shades
- Double honeycomb, Commercial 3/4" opaque, Royale and Classic Eclipse™ fabrics in angle bottom or angle top shades greater than 45 degrees

ORDERING CHECKLIST

- ✓ Specify inside (IB) or outside (OB) mount.
- ✓ Specify whether the shade is operable or stationary.
- ✓ Specify optional brackets or spacer blocks, if required.
- ✓ Cordlock on angle top shades must always be at the lower end of the headrail.
- ✓ Specify left or right cord position on angle bottom shades.
- ✓ Include a template with each shade ordered. See template preparation instructions in the General Information section — Measuring Guidelines.

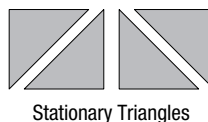
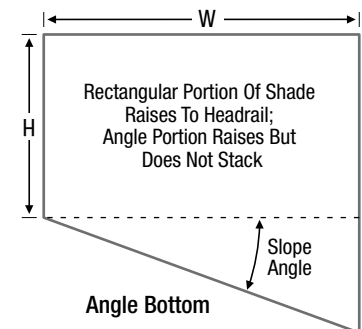
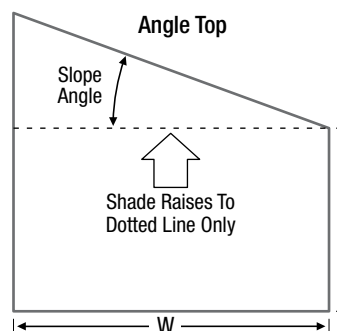
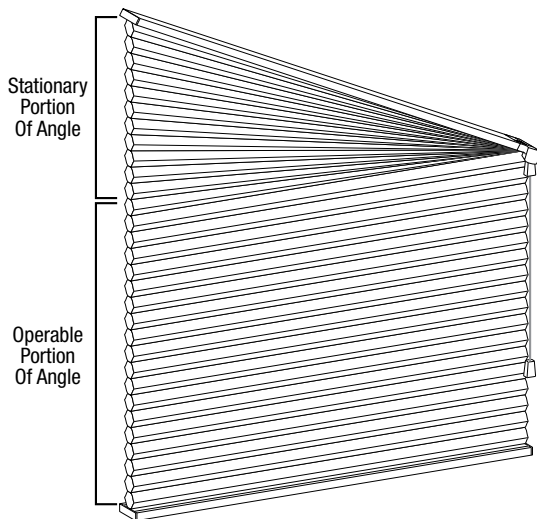

APPLICATIONS

- Fits rectangular window openings.
- Standard or Top-Down operation.
- Remote control battery-powered operation is standard.
- Optional components available (see page DU-61).

Size Standards

See Size Standards on page DU-14 and DU-15

Mounting Requirements

3/8" Pleat

Inside (IB) Mount/End (EB) Mount

Minimum mounting depth	11/16"
------------------------	--------

Minimum mounting depth, flush mount	2"
-------------------------------------	----

Outside (OB) Mount

Minimum flat vertical surface	3/4"
-------------------------------	------

3/4" Pleat, Double and Triple Honeycomb

Inside (IB) Mount/End (EB) Mount

Minimum mounting depth	11/16"
------------------------	--------

Minimum mounting depth, flush mount	2 1/2"
-------------------------------------	--------

Outside (OB) Mount

Minimum flat vertical surface	3/4"
-------------------------------	------

1 1/4" Pleat

Inside (IB) Mount

Minimum mounting depth	11/16"
------------------------	--------

Minimum mounting depth, flush mount	3"
-------------------------------------	----

Outside (OB) Mount

Minimum flat vertical surface	3/4"
-------------------------------	------

Note: For headrail dimensions please refer to the General Information section — Measuring Guidelines of this Reference Guide.

Finished Dimensions

(All allowances are taken from ordered dimensions and may vary slightly.)

Inside (IB) Mount

Headrail unit	-3/16"
---------------	--------

Shade height	ordered height
--------------	----------------

Fabric width	-3/8"
--------------	-------

Outside (OB) Mount

Headrail unit	ordered width
---------------	---------------

Shade height	ordered height
--------------	----------------

Fabric width	-3/16"
--------------	--------

End (EB) Mount

Headrail unit	-11/16"
---------------	---------

Shade height	ordered height
--------------	----------------

Fabric width	-7/8"
--------------	-------

Hardware Included

Installation brackets

Optional Features

No Charge — Specify on Order

Spacer blocks

Extension brackets

Surcharge — Specify on Order

Cut-outs — standard only (see page DU-66)

Note: See page DU-45 for PowerRise® with Platinum™ Technology surcharges.

HARDWARE COLORS

- Headrail and bottom rail colors will complement the fabric selection.
- Bottom rail (and center rail) can be coordinated to the shade fabric if specified when ordering (except 1 1/4" fabrics).

HOW TO PRICE

- **Important Note!** All base prices are predicated on Ordered Dimensions, not Finished Dimensions.
- Locate the suggested Cordlock or TruRise® Standard base price of the shade using charts A1 to A15 (see pages DU-16 to DU-30).
- Add width-based PowerRise with Platinum Technology surcharge to base price.
- Add surcharge for at least one hand-held Platinum remote or wireless wall switch.
- Add surcharges for any additional options ordered as shown on page DU-45.

EXCLUSIONS

- Arches over PowerRise shades
- Marine use

ORDERING CHECKLIST

- ✓ Specify inside (IB), outside (OB) or end (EB) mount. Order extension brackets for end mount applications.
- ✓ Specify Top-Down option, if desired.
- ✓ Specify color-coordinated bottom rail (and center rail), if desired.
- ✓ Specify for outside mounts if spacer blocks are needed for added clearance.
- ✓ Specify left- or right-side infrared eye (even if ordering satellite eye).
- ✓ Specify number of Platinum remotes or wireless wall switches required.
- ✓ If ordering Platinum satellite eye, specify wire length: 20', 4' or 8'.
- ✓ If ordering satellite battery pack, specify wire length: 15', 4' or 8'.
- ✓ If ordering DC power supply, specify wire length: 12', 16' or 25'.
- ✓ Specify IR channel 2 operation for independent infrared operation of adjacent or stacked shades.
- ✓ Specify if daisy-chain cables are required to daisy-chain up to three shades (requires DC power supply).

Note: Keep in mind which side the satellite eye is positioned on each shade when determining daisy-chain length.

PowerRise® with Platinum™ Technology Skylight Product Specifications

DUETTE® HONEYCOMB SHADES

APPLICATIONS

- Fits rectangular window openings.
- Ideal for skylight windows.
- Remote control battery-powered operation is standard.
- Available in a top stack only.

Size Standards

See Size Standards on pages DU-8 to DU-10

Mounting Requirements

³/₄" Pleat Only

Inside (IB) Mount

Minimum mounting depth	2 ¹ / ₂ "
------------------------	---------------------------------

Minimum mounting depth, flush mount	3"
-------------------------------------	----

Outside (OB) Mount

Recommended OB overlap	2 ¹ / ₂ "
------------------------	---------------------------------

Minimum OB flat mount	1 ¹ / ₂ "
-----------------------	---------------------------------

Note: Headrail height is 2³/₄".

Finished Dimensions

(All allowances are taken from ordered dimensions and may vary slightly.)

Inside (IB) Mount

Frame width	- ³ / ₈ "
-------------	---------------------------------

Frame height	- ³ / ₈ "
--------------	---------------------------------

Fabric width	-2 ¹ / ₂ "
--------------	----------------------------------

Outside (OB) Mount

Frame width	+2 ¹ / ₂ "
-------------	----------------------------------

Frame height	+2 ¹ / ₂ "
--------------	----------------------------------

Fabric width	ordered width
--------------	---------------

Hardware Included

Installation brackets

SKYLIGHT BATTERY PACK

- PowerRise® Skylight battery life is approximately two years, depending on usage.
- Each PowerRise with Platinum™ Technology skylight shade comes with a battery pack.
- Consumers will need to order replacement batteries through a Hunter Douglas dealer since the PowerRise skylight product cannot use regular alkaline batteries. Pricing for the Skylight Replacement Battery Pack can be found on page DU-45.
- 2¹/₄" wide x 9" high x 1³/₄" deep.

HARDWARE COLORS

- Hardware available in 785 Aspen White only.

HOW TO PRICE

- **Important Note!** All base prices are predicated on Ordered Dimensions, not Finished Dimensions.
- Locate the suggested Cordlock Standard base price of the shade using charts A2 to A10 (see pages DU-17 to DU-23).
- Add width-based PowerRise with Platinum Technology skylight surcharge to base price.
- Add surcharge for at least one hand-held Platinum remote or wireless wall switch.
- Add surcharges for any options ordered as shown in the Other Surcharges chart on page DU-45.

EXCLUSIONS

- ³/₈" pleat fabrics
- 1¹/₄" pleat fabrics
- Architella® fabrics
- Ariosa™ fabric
- Commercial fabric
- Double honeycomb fabrics
- Phenomena™ triple honeycomb fabric
- Arches over PowerRise shades
- Marine use
- Satellite battery pack
- End (EB) mounts
- Side-to-side orientation

ORDERING CHECKLIST

- ✓ Specify inside (IB) or outside (OB) mount.
- ✓ Specify left- or right-side infrared eye (even if ordering satellite eye).
- ✓ Specify number of Platinum remotes or wireless wall switches.
- ✓ If ordering Platinum satellite eye, specify wire length: 20', 4' or 8'.
- ✓ Specify IR channel 2 operation for independent infrared operation of adjacent or stacked shades.

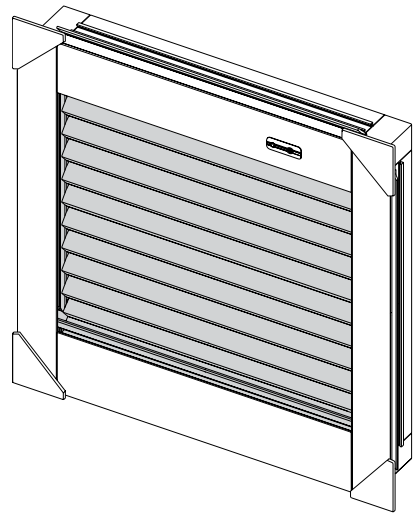

APPLICATIONS

- Fits rectangular window openings on any slope or in any orientation.
- Optional switch control or optional remote control operation.

Size Standards

See Size Standards on pages DU-8 to DU-10

Mounting Requirements

Inside (IB) Mount

Minimum mounting depth	1½"
Minimum mounting depth, flush mount	2"

Outside (OB) Mount

Minimum flat vertical surface	½"
-------------------------------	----

Finished Dimensions

(All allowances are taken from ordered dimensions and may vary slightly.)

Inside (IB) Mount

Headrail unit	-5/16"
Shade height	-3/8"
Fabric width	-1¼"

Outside (OB) Mount

Headrail unit	+7/16"
Shade height	+1/8"
Fabric width	-1¼"

Note: All finished dimensions include side tracks.

Hardware Included

Inside (IB) mount: Installation brackets
Outside (OB) mount: Universal mounting brackets
Support cord for shades over 48" wide

Optional Features

Note: See page DU-45 for Hard-Wired Motorization surcharges.

COMPONENT DIMENSIONS

Power Supply

- 3 amp — 2¼" w x 1⅛" h x 5⅛" d (powers up to two shades).

HARDWARE COLORS

- Available in 785 Aspen White only.

HOW TO PRICE

- **Important Note!** All base prices are predicated on Ordered Dimensions, not Finished Dimensions.
- Suggested base prices of manual Skyrise® shades shown on base price charts D1, D3 and D5 (see pages DU-35, DU-37 and DU-39).
- For stack bottom shades, add width-based surcharge.
- Add the appropriate Hard-Wired Motorization surcharges to total price of manual shade. See page DU-45.

Note

- For further details about Hard-Wired Motorization, please refer to the General Information section — Motorization and Automation of this Reference Guide.

EXCLUSIONS

- Duolite™
- 1¼" pleat fabrics
- Commercial fabrics
- Architella® fabrics
- Ariosia™ fabric
- Double honeycomb fabrics

ORDERING CHECKLIST

- ✓ Motor-only shades will not function without being wired directly to a Platinum™ wall switch or other motor control device (i.e., home automation system). When using the Platinum wall switch option:
 - One Platinum wall switch is required per shade.
 - One Platinum remote is required for optional remote control operation.
- ✓ One 3-amp 24V power supply can power up to two shades; one 4-amp 24V power supply can power up to four shades. For maximum wire lengths, refer to the Wire Gauge Guide in the General Information section — Motorization and Automation of this Reference Guide.
- ✓ Specify inside (IB) or outside (OB) mount.
- ✓ Specify optional mounting hardware or other optional features, including Hard-Wired Motorization components.
- ✓ For stack side applications, use width specifications for height and height specifications for width.

Hard-Wired Motorization Product Specifications

DUETTE® HONEYCOMB SHADES

APPLICATIONS

- Fits rectangular window openings.
- Optional switch control or optional remote control operation.

Size Standards

See Size Standards on pages DU-8 to DU-10

Mounting Requirements

³/₈" and ³/₄" Pleat, Double and Triple Honeycomb
Inside (IB) Mount

Minimum mounting depth	1 ¹ / ₈ "
Minimum mounting depth, flush mount	2 ¹ / ₄ "

Outside (OB) Mount

Minimum flat vertical surface	1"
-------------------------------	----

1¹/₄" Pleat

Inside (IB) Mount

Minimum mounting depth	1 ¹ / ₈ "
Minimum mounting depth, flush mount	3 ¹ / ₂ "

Outside (OB) Mount

Minimum flat vertical surface	1 ¹ / ₂ "
-------------------------------	---------------------------------

Finished Dimensions

(All allowances are taken from ordered dimensions and may vary slightly.)

Inside (IB) Mount

Headrail unit	- ³ / ₁₆ "
Shade height	ordered height
Fabric width	- ³ / ₈ "

Outside (OB) Mount

Headrail unit	ordered width
Shade height	ordered height
Fabric width	- ³ / ₁₆ "

Hardware Included

Installation brackets

Optional Features

No Charge — Specify on Order

Spacer blocks

Extension brackets

Hold-down brackets

Surcharge — Specify on Order

Cut-outs (see page DU-66)

Note: See page DU-45 for Hard-Wired Motorization surcharges.

COMPONENT DIMENSIONS

24V DC Power Supplies

- 3 amp — 2¹/₄" w x 1¹/₈" h x 5¹/₈" d (powers up to two shades)
- 4 amp — 8¹/₈" w x 2¹/₄" h x 4¹/₂" d (powers up to four shades)

HARDWARE COLORS

- Headrail available in 785 Aspen White only.
- Bottom rail will be color coordinated to fabric.
- Bottom rail color for 1¹/₄" will complement the fabric.

HOW TO PRICE

- **Important Note!** All base prices are predicated on Ordered Dimensions, not Finished Dimensions.
- Add Hard-Wired Motorization surcharges to the total price of a manual EasyRise™ shade (see page DU-45). Standard base price shown on price charts A1 to A15 (see pages DU-16 to DU-30).

EXCLUSIONS

- Duolite™
- End (EB) mounts
- Two-On-One Headrail

ORDERING CHECKLIST

- ✓ Motor-only shades will not function without being wired directly to a Platinum™ wall switch or other motor control device (i.e., home automation system). When using the Platinum wall switch option:
 - One Platinum wall switch is required per shade.
 - One Platinum remote is required for optional remote control operation.
- ✓ One 3-amp 24V power supply can power up to two shades; one 4-amp 24V power supply can operate up to four shades.
- ✓ Specify inside (IB) or outside (OB) mount.
- ✓ Specify additional options, if desired, such as special mounting hardware.

Note

- For further details about Hard-Wired Motorization, please refer to the General Information section — Motorization and Automation of this Reference Guide.

Cut-Out Product Specifications and Stacking Height Specifications

DUETTE® HONEYCOMB SHADES

APPLICATIONS

- Cut-outs are suggested for clearance around obstructions.
- Cut-outs may be at the bottom of the shade only, on either or both sides.
- Available with the following:
 - Single panel Cordlock, UltraGlide® and EasyRise™ Standard shades
 - PowerRise® Standard shades
 - Vertiglide™ shades

Size Standards

Cordlock, UltraGlide, EasyRise and PowerRise

Width	
Maximum	3"
Height†	
Maximum	Top of cut-out must be greater than 12" from the headrail

Vertiglide

Width	
Required*	1"
Height†	
Maximum	6"

*1" is the only cut-out width available for Vertiglide shades.

†Height of cut-out is measured from the floor to the top of the desired cut-out location.

HOW TO PRICE

- **Important Note!** All base prices are predicated on Ordered Dimensions, not Finished Dimensions.
- Add surcharge per cut-out to base price shown on charts A1 to A15 (see pages DU-16 to DU-30) or E1 to E10 (see pages DU-40 to DU-44).
- Add Duette® with EasyRise, PowerRise or UltraGlide surcharge if applicable.

EXCLUSIONS

- Double honeycomb fabrics
- Phenomena™ triple honeycomb fabric
- Top-Down
- Top-Down/Bottom-Up
- Two-On-One Headrail
- Duolite™ option
- LiteRise® system
- TruRise® system
- PowerRise skylight
- Skyrise® system
- Simplicity™ system
- Arches
- Angles
- Specialty shapes
- Sidelights

ORDERING CHECKLIST

- ✓ Cut-outs on Vertiglide shades are available for inside flush (IB) and inside non-flush (NB) mounts only.
- ✓ Vertiglide shade height must be 60" or greater.
- ✓ Available only on single honeycomb fabric.
- ✓ Bottom rail will be cut out on standard shades. Side rail will be cut out on Vertiglide shades.
- ✓ Specify cut-out dimensions.
- ✓ Specify whether cut-out should be made on the right or left side of shade on both sides.
- ✓ Only bottom side cut-outs are available.

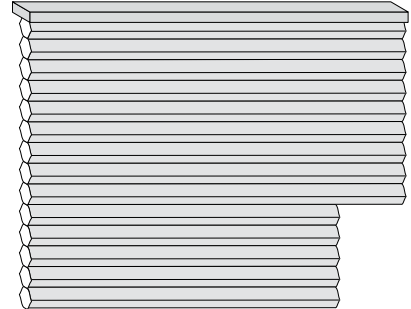

Shade Stacking Heights (Rails only.)

HARDWARE SYSTEM	RAIL HEIGHTS TO BE ADDED TO THE ABOVE
Cordlock Standard Shades	1"
Cordlock Top-Down/Bottom-Up and Duolite Shades	1 1/2"
EasyRise, LiteRise and UltraGlide Standard (All Pleat Sizes, Double and Triple Honeycomb)	1 7/8"
EasyRise, LiteRise and UltraGlide Top-Down/Bottom-Up and Duolite Shades (All Pleat Sizes, Double and Triple Honeycomb)	2 3/8"
PowerRise Standard (3/8" and 3/8" Pleat, Double and Triple Honeycomb)	2 1/8"
PowerRise Standard (1 1/4" Pleat)	2"
TruRise Standard (1 1/4" Pleat)	1 7/8"

Notes:

- Add fabric and rail stack heights together for complete stacking height.
- Fabric stacking heights are shown on the following page.
- Shade stacking heights applicable only when shade is in the fully raised position.
- Stacking heights do not apply to Top-Down shades.

Vertiglide Fabric Stacking 6 1/2"

Fabric stacking dimensions determined by shade hardware, not ordered width.