

Applause[®] Honeycomb Shades

STYLE AND VARIETY

Several fabric and pleat options:

- 3/8" and 3/4" semi-opaque fabrics
- 3/8" and 3/4" blackout fabrics
- Double honeycomb fabrics
- Sunterra™ fabric features warm whites and rich organic hues

WIDE VARIETY OF LIFTING SYSTEMS

Applause with Cordlock (AP-23)

- Standard
- Top-Down
- Top-Down/Bottom-Up
- Duolite™
- Two-On-One Headrail

Applause with LiteRise® (AP-24)

- Standard
- Top-Down/Bottom-Up
- Duolite
- TrimKit

Applause with EasyRise™ (AP-25)

- Standard
- Top-Down/Bottom-Up
- Duolite
- Two-On-One Headrail

Applause with Vertiglide™ (AP-26)

- Standard
- Duolite

Sidelights (AP-27)

- Non-Operable
- Cordless Operable

Applause with Simplicity™ (AP-28)

Applause with Skyrise® (AP-29)

Arches and Circles (AP-30)

Angles (AP-31)

Specialty Shapes (AP-32)

Applause PowerRise® with Platinum™ Technology (AP-33)

- Standard
- Top-Down

Cut-Outs (AP-36)

CONTENTS

Size Standards	AP-2
Pricing	AP-6
Product Specifications.....	AP-23
Stacking Heights.....	AP-37

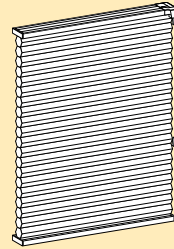

Applause
With Cordlock
AP-23

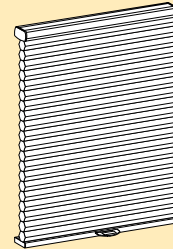

Applause
With LiteRise
AP-24

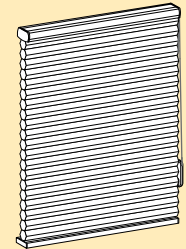

Applause
With EasyRise
AP-25

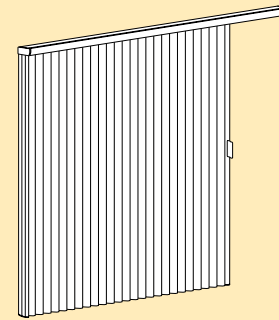

Applause With Vertiglide
AP-26

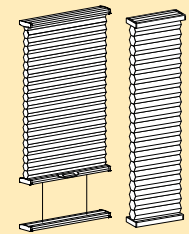

Sidelights
AP-27

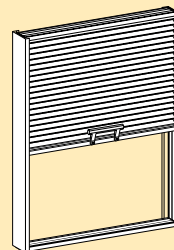

Applause
With Simplicity
AP-28

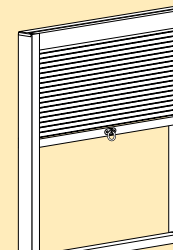

Applause
With Skyrise
AP-29

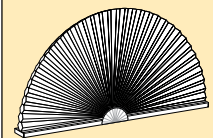

Arches, Circles
And Quarter Circles
AP-30

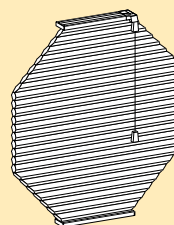

Hexagons, Octagons
And Trapezoids
AP-32

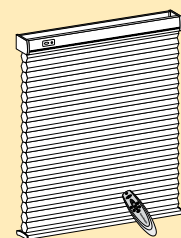

Applause With PowerRise
AP-33

Size Standards: EasyRise™, Sidelights and Specialty Hardware Systems

APPLAUSE® HONEYCOMB SHADES

SIZE STANDARDS	EasyRise™ Standard AP-25	EasyRise Top-Down/ Bottom-Up AP-25	EasyRise Two-On-One Headrail AP-25	EasyRise Duolite™ AP-25	Non-Operable Sidelight AP-27	Cordless Operable Sidelight AP-27	Simplicity™ AP-28	Skyrise® AP-29	Vertiglide™ AP-26
E1 LEGENDS™ 3/8" SEMI-OPAQUE (Price Charts A2, B2, C2 and D2)									
Width:	174"	174"	174"	174"	11 7/8"	17 7/8"	60"	96"	—
Height:	144"	144"	144"	144"	120"	84"	72"	144"	—
Area (sq. ft.):	150	150	150/panel	100/panel			25	80	
E3 LEGENDS 3/4" BLACKOUT (Price Charts A6, B3, C5, D4 and E4)									
Width:	174"	174"	174"	174"	11 7/8"	17 7/8"	60"	96"	168"
Height:	144"	144"	144"	144"	120"	84"	72"	174"	120"
Area (sq. ft.):	150	150	150/panel	80/panel			25	50	140
E4 LEGENDS 3/8" BLACKOUT (Price Charts A6, B3, C5 and D4)									
Width:	174"	174"	174"	174"	11 7/8"	17 7/8"	60"	96"	—
Height:	144"	144"	144"	144"	120"	84"	72"	144"	—
Area (sq. ft.):	150	150	150/panel	100/panel			25	50	
E5 LEGENDS DOUBLE HONEYCOMB (Price Charts A4, B3 and C3)									
Width:	174"	174"	174"	174"	11 7/8"	17 7/8"	60"	—	—
Height:	144"	144"	144"	144"	120"	84"	72"	—	—
Area (sq. ft.):	150	150	150/panel	80/panel			25		
E6 LEGENDS 3/4" SEMI-OPAQUE (Price Charts A3, B2, C2, D2 and E2)									
Width:	174"	174"	174"	174"	11 7/8"	17 7/8"	60"	96"	140"
Height:	144"	144"	144"	144"	120"	84"	72"	192"	120"
Area (sq. ft.):	150	150	150/panel	80/panel			25	80	116
E12 PURESSENCE™ 3/4" SEMI-OPAQUE (Price Chart A7)									
Width:	174"	174"	174"	174"	11 7/8"	17 7/8"	—	—	—
Height:	144"	144"	144"	144"	120"	84"	—	—	—
Area (sq. ft.):	105	105	105/panel	60/panel					
E15 CASUELLE® DOUBLE HONEYCOMB (Price Charts A4, B4 and C3)									
Width:	174"	174"	174"	174"	11 7/8"	17 7/8"	60"	—	—
Height:	144"	144"	144"	144"	120"	84"	72"	—	—
Area (sq. ft.):	150	150	150/panel	60/panel			25		
E16 CASUELLE 3/4" SEMI-OPAQUE (Price Charts A3, B2, C2, D2 and E2)									
Width:	174"	174"	174"	174"	11 7/8"	17 7/8"	60"	96"	168"
Height:	144"	144"	144"	144"	120"	84"	72"	192"	120"
Area (sq. ft.):	150	150	150/panel	80/panel			25	80	140
E17 CASUELLE 3/4" BLACKOUT (Price Charts A6, B3, C5, D4 and E4)									
Width:	174"	174"	174"	174"	11 7/8"	17 7/8"	60"	96"	168"
Height:	144"	144"	144"	144"	120"	84"	72"	174"	120"
Area (sq. ft.):	150	150	150/panel	80/panel			25	50	140
E18 CASUELLE 3/8" SEMI-OPAQUE (Price Charts A2, B2, C2 and D2)									
Width:	174"	174"	174"	174"	11 7/8"	17 7/8"	60"	96"	—
Height:	144"	144"	144"	144"	120"	84"	72"	144"	—
Area (sq. ft.):	150	150	150/panel	100/panel			25	80	
E40 SUNTERRA™ 3/4" SEMI-OPAQUE (Price Charts A1, B1, C1, D1 and E1)									
Width:	174"	174"	174"	174"	11 7/8"	17 7/8"	60"	96"	168"
Height:	144"	144"	144"	144"	120"	84"	72"	192"	120"
Area (sq. ft.):	150	150	150/panel	80/panel			25	80	140
E41 SUNTERRA 3/4" BLACKOUT (Price Chart A5, B2, C4, D3 and E3)									
Width:	174"	174"	174"	174"	11 7/8"	17 7/8"	60"	96"	168"
Height:	144"	144"	144"	144"	120"	84"	72"	144"	120"
Area (sq. ft.):	150	150	150/panel	80/panel			25	40	140
MINIMUMS									
Width:	12"	24"	12"/panel	24"	4"	6"	18"	12"	12"
Height:	24"	24"	24"	24"	6"	6"	6"	18"	24"

Notes for pages AP-2 and AP-3:

- Maximum width for end-mounted shades is 36" (48" with support cord for Cordlock systems).
- Duolite shades: blackout fabric is available on bottom panel only.
- Duolite shades: use the smaller of the two maximum areas for the maximum area per panel.
- Skyrise system: maximum areas listed apply to stack top shades with a slope of 45 degrees or less; maximum area varies with slope angle; see page AP-29.
- Skyrise system: maximum area of stack side shades is 50 sq. ft.; maximum area of stack bottom shades is 35 sq. ft.
- Skyrise and Simplicity systems: with stack side shades, use maximum width for maximum height and maximum height for maximum width.
- Vertiglide system: specifications are per panel for Duolite designs; split stack designs wider than the maximum single shade width will be fabricated as two separate shades; the supplied valance will create the appearance of a single shade.

Size Standards: Specialty Shapes

APPLAUSE® HONEYCOMB SHADES

SIZE STANDARDS	Arch AP-30	Circle AP-30	Quarter Circle AP-30	Angle 0° – 30° Slope AP-31	Angle 30° – 45° Slope AP-31	Angle 45° – 60° Slope AP-31	Hexagon AP-32	Octagon AP-32	Trapezoid AP-32
E1 LEGENDS™ 3/8" SEMI-OPAQUE (Price Charts A2, B2, C2 and D2)									
Width:	60"	48"	42"	70"	60"	42"	30"	30"	72"
Height:	1/2 width	48"	42"	84"	84"	84"	30"	30"	96"
Area (sq. ft.):				41	35	24			48
E3 LEGENDS 3/4" BLACKOUT (Price Charts A6, B3, C5, D4 and E4)									
Width:	84"	68"	42"	48"	48"	—	30"	30"	72"
Height:	1/2 width	68"	42"	72"	72"	—	30"	30"	96"
Area (sq. ft.):				24	24				40
E4 LEGENDS 3/8" BLACKOUT (Price Charts A6, B3, C5 and D4)									
Width:	60"	48"	42"	48"	48"	—	30"	30"	72"
Height:	1/2 width	48"	42"	72"	72"	—	30"	30"	96"
Area (sq. ft.):				24	24				40
E5 LEGENDS DOUBLE HONEYCOMB (Price Charts A4, B3 and C3)									
Width:	84"	—	—	48"	36"	—	30"	30"	72"
Height:	1/2 width	—	—	84"	84"	—	30"	30"	96"
Area (sq. ft.):				28	21				40
E6 LEGENDS 3/4" SEMI-OPAQUE (Price Charts A3, B2, C2, D2 and E2)									
Width:	84"	48"	42"	48"	48"	38"	30"	30"	72"
Height:	1/2 width	48"	42"	84"	84"	72"	30"	30"	96"
Area (sq. ft.):				28	28	19			48
E12 PURESSENCE™ 3/4" SEMI-OPAQUE									
Width:	—	—	—	—	—	—	—	—	—
Height:	—	—	—	—	—	—	—	—	—
Area (sq. ft.):									
E15 CASUELLE® DOUBLE HONEYCOMB (Price Charts A4, B4 and C3)									
Width:	84"	—	—	48"	36"	—	30"	30"	72"
Height:	1/2 width	—	—	72"	72"	—	30"	30"	96"
Area (sq. ft.):				24	18				40
E16 CASUELLE 3/4" SEMI-OPAQUE (Price Charts A3, B2, C2, D2 and E2)									
Width:	72"	48"	42"	48"	48"	38"	30"	30"	72"
Height:	1/2 width	48"	42"	84"	84"	72"	30"	30"	96"
Area (sq. ft.):				28	28	19			48
E17 CASUELLE 3/4" BLACKOUT (Price Charts A6, B3, C5, D4 and E4)									
Width:	84"	68"	42"	48"	48"	—	30"	30"	72"
Height:	1/2 width	68"	42"	72"	72"	—	30"	30"	96"
Area (sq. ft.):				24	24				40
E18 CASUELLE 3/8" SEMI-OPAQUE (Price Charts A2, B2, C2 and D2)									
Width:	60"	48"	42"	70"	60"	42"	30"	30"	72"
Height:	1/2 width	48"	42"	84"	84"	84"	30"	30"	96"
Area (sq. ft.):				41	35	24			48
E40 SUNTERRA™ 3/4" SEMI-OPAQUE (Price Charts A1, B1, C1, D1 and E1)									
Width:	72"	48"	42"	48"	48"	38"	30"	30"	72"
Height:	1/2 width	48"	42"	84"	84"	72"	30"	30"	96"
Area (sq. ft.):				28	28	19			48
E41 SUNTERRA 3/4" BLACKOUT (Price Chart A5, B2, C4, D3 and E3)									
Width:	84"	68"	42"	48"	48"	—	30"	30"	72"
Height:	1/2 width	68"	42"	72"	72"	—	30"	30"	96"
Area (sq. ft.):				24	24				40
MINIMUMS									
Width:	12"	12"	12"	12"	12"	12"	8"	8"	8"
Height:	9"	12"	12"	6"	6"	6"	8"	8"	8"

Note:

• Double honeycomb fabrics not available as Angle Bottom shades.

Size Standards: PowerRise® with Platinum™ Technology

APPLAUSE® HONEYCOMB SHADES

POWERRISE® WITH PLATINUM™ TECHNOLOGY SIZE STANDARDS: STANDARD AND TOP-DOWN (AP-33)																
Width To:	24"	30"	36"	42"	48"	54"	60"	66"	72"	84"	96"	108"	120"	132"	144"	156"
E1 LEGENDS™ 3/8" SEMI-OPAQUE (Price Chart A2)																
Maximum Height:	96"	96"	96"	96"	96"	96"	96"	96"	96"	96"	96"	96"	96"	96"	96"	96"
E3 LEGENDS 3/4" BLACKOUT (Price Chart A6)																
Maximum Height:	96"	96"	96"	96"	96"	96"	96"	90"	78"	66"	54"	42"	36"	—	—	—
E4 LEGENDS 3/8" BLACKOUT (Price Chart A6)																
Maximum Height:	96"	96"	96"	96"	96"	96"	96"	96"	96"	84"	60"	36"	—	—	—	—
E5 LEGENDS DOUBLE HONEYCOMB (Price Chart A4)																
Maximum Height:	96"	96"	96"	96"	96"	96"	96"	96"	96"	96"	90"	78"	66"	54"	48"	36"
E6 LEGENDS 3/4" SEMI-OPAQUE (Price Chart A3)																
Maximum Height:	96"	96"	96"	96"	96"	96"	96"	96"	96"	96"	96"	96"	84"	72"	60"	54"
E12 PURESSENCE™ 3/4" SEMI-OPAQUE (Price Chart A7)																
Maximum Height:	96"	96"	96"	96"	96"	96"	96"	96"	96"	78"	66"	54"	42"	36"	—	—
E15 CASUELLE® DOUBLE HONEYCOMB (Price Chart A4)																
Maximum Height:	96"	96"	96"	96"	96"	96"	96"	96"	96"	78"	54"	42"	30"	—	—	—
E16 CASUELLE 3/4" SEMI-OPAQUE (Price Chart A3)																
Maximum Height:	96"	96"	96"	96"	96"	96"	96"	96"	96"	96"	96"	96"	90"	78"	66"	54"
E17 CASUELLE 3/4" BLACKOUT (Price Chart A6)																
Maximum Height:	96"	96"	96"	96"	96"	96"	96"	84"	66"	42"	—	—	—	—	—	—
E18 CASUELLE 3/8" SEMI-OPAQUE (Price Chart A2)																
Maximum Height:	96"	96"	96"	96"	96"	96"	96"	96"	96"	96"	96"	96"	96"	90"	78"	66"
E40 SUNTERRA™ 3/4" SEMI-OPAQUE (Price Chart A1)																
Maximum Height:	96"	96"	96"	96"	96"	96"	96"	96"	96"	96"	96"	96"	90"	78"	66"	54"
E41 SUNTERRA 3/4" BLACKOUT (Price Chart A5)																
Maximum Height:	96"	96"	96"	96"	96"	96"	96"	96"	96"	96"	96"	90"	72"	60"	54"	42"
MINIMUMS																
Width:	19"															
Height:	6"															

- Maximum width for end-mounted PowerRise shades is 65".
- Arches and Quarter Circles cannot share the PowerRise headrail.

APPLICATIONS

- Standard
- Top-Down
- Top-Down/Bottom-Up
- Duolite™
- Two-On-One Headrail
 - Available with either Bottom-Up or Top-Down operation

Size Standards

See Size Standards on page AP-2

Mounting Requirements

3/8" Pleat

Inside (IB) Mount

Minimum mounting depth:	
Standard installation bracket	1"
Swivel bracket	1/2"

Minimum mounting depth, flush mount:

Standard installation bracket	1 1/2"
Swivel bracket	1 1/8"
End mount bracket	1 1/8"

Outside (OB) Mount

Minimum flat vertical surface:	
Standard installation bracket	5/8"

3/4" Pleat and Double Honeycomb

Inside (IB) Mount

Minimum mounting depth:	
Standard installation bracket	1 1/4"
Swivel bracket	1/2"

Minimum mounting depth, flush mount:

Standard installation bracket	2 1/4"
Swivel bracket	2"
End mount bracket	2"

Outside (OB) Mount

Minimum flat vertical surface:	
Standard installation bracket	1"

Notes:

- Cordlock cover will add an additional 5/8" of depth at operable end(s) of headrail.
- For headrail dimensions, please refer to the General Information section — Measuring Guidelines of this Reference Guide.

Finished Dimensions

(All allowances are taken from ordered dimensions and may vary slightly.)

Inside (IB) Mount

Headrail unit	-3/16"
Shade height	ordered height
Fabric width	-3/8"

Outside (OB) Mount

Headrail unit	ordered width
Shade height	ordered height
Fabric width	-3/16"

End (EB) Mount

Headrail unit	-3/16"
Shade height	ordered height
Fabric width	-3/8"

Two-On-One Headrail

Gap between fabric panels	-1/4"
---------------------------	-------

Hardware Included

Installation brackets

Optional Features

No Charge — Specify on Order

Swivel brackets (inside mounts only)

End mount brackets

Spacer blocks

Extension brackets

Hold-down brackets

Cord length

Surcharge — Specify on Order

Cut-outs (standard only; see page AP-36)

HOW TO PRICE

- **Important Note!** All base prices are predicated on Ordered Dimensions, not Finished Dimensions.
- Base prices shown on price charts A1 to A7 (see pages AP-6 to AP-12).
- With Duolite and Two-On-One Headrail shades, price each fabric panel as a separate Cordlock shade and add together.
- Add any applicable surcharges shown below price chart for Top-Down and Top-Down/Bottom-Up shades.

EXCLUSIONS

- Two-On-One Headrail as end (EB) mounts
- Two-On-One Headrail with hold-down brackets
- Top-Down/Bottom-Up with Two-On-One Headrail
- Duolite with Two-On-One Headrail

ORDERING CHECKLIST

- ✓ Specify inside (IB), outside (OB) or end (EB) mount.
- ✓ Standard and Top-Down only: specify left- or right-side lift cord.
- ✓ Specify optional mounting hardware or other optional features.

Duolite Only

- ✓ On order form, list top fabric panel first and bottom fabric panel second.
- ✓ Different pleat sizes cannot be combined on the same shade.
- ✓ Double honeycomb fabrics may be used in combination with any 3/4" pleat size.
- ✓ Blackout fabric is available on bottom panel only.
- ✓ All hardware will coordinate with the bottom panel fabric selection.

APPLICATIONS

- Standard
- Top-Down/Bottom-Up
- **Duolite™**
- Two-On-One Headrail
- All applications include color-coordinated, fabric-covered valance

Note: To operate *Duolite* and *Top-Down/Bottom-Up* shades, the right cord operates the center rail and the left cord operates the bottom rail. "Reverse Controls" are not available.

Size Standards

See Size Standards on page AP-3

Mounting Requirements

³/₈" Pleat

Inside (IB) Mount/End (EB) Mount

Minimum mounting depth, inside mount 1/2"

Minimum mounting depth, end mount 1 1/4"

Minimum mounting depth, flush mount 2 1/4"

Outside (OB) Mount

Minimum flat vertical surface 1 1/4"

³/₄" Pleat and Double Honeycomb

Inside (IB) Mount/End (EB) Mount

Minimum mounting depth, inside mount 1/2"

Minimum mounting depth, end mount 1 1/4"

Minimum mounting depth, flush mount 2 7/8"

Outside (OB) Mount

Minimum flat vertical surface 1 1/8"

Note: For headrail dimensions please refer to the General Information section — *Measuring Guidelines of this Reference Guide*.

Hardware Included

Installation brackets

Finished Dimensions

(All allowances are taken from ordered dimensions and may vary slightly.)

Inside (IB) Mount

Headrail unit -³/₁₆"

Shade height ordered height

Fabric width -³/₈"

Outside (OB) Mount

Headrail unit

Standard +1/2"

Top-Down/Bottom-Up and

Two-On-One Headrail +1"

Shade height ordered height

Fabric width ordered width

End (EB) Mount

Headrail unit -¹¹/₁₆"

Shade height ordered height

Fabric width -⁷/₈"

Two-On-One Headrail

Gap between fabric panels 1/4"

IMPORTANT

In accordance with the revised American National Standard for Safety of Corded Window Covering Products, EasyRise shades require proper mounting of the cord tensioner for the product to function properly. The cord tensioner should not be modified in any way.

Optional Features

No Charge — Specify on Order

Spacer blocks

Extension brackets (required for end mounts)

Hold-down brackets

Cord loop drops

Surcharge — Specify on Order

Cut-outs (standard only; see page AP-36)

Cord Loop

Standard Cord Drops — Color Coordinated

Shade height 24" to 39 7/8" 2'

Shade height 40" to 59 7/8" 3'

Shade height 60" to 83 7/8" 4'

Shade height 84" to 107 7/8" 5'

Shade height 108" to 144" Must be specified*

Optional Cord Drops — White Only

18" to 12' in 6" increments

12' to 16' in 12" increments

*Cord loops greater than 5' will come in white.

Note: All optional cord loop drops must be specified on order form.

HARDWARE COLORS

- Cord tensioner will be color coordinated to fabric.
- Bottom rail and center rail (if applicable) will coordinate to shade fabric.

HOW TO PRICE

- **Important Note!** All base prices are predicated on Ordered Dimensions, not Finished Dimensions.
- Add width-based Applause® with EasyRise surcharge to Cordlock Standard base price shown on charts A1 to A7 (see pages AP-6 to AP-12).
- With Two-On-One Headrail shades, price each fabric panel as a separate EasyRise shade and add together.
- Add Top-Down/Bottom-Up surcharge, if ordered.

EXCLUSIONS

- End (EB) mount shades over 36" wide
- Two-On-One Headrail with hold-down brackets
- Two-On-One Headrail with Top-Down/Bottom-Up
- Two-On-One Headrail shades as end (EB) mounts

ORDERING CHECKLIST

- ✓ Specify inside (IB), outside (OB) or end (EB) mount. Order extension brackets for end mount applications.
- ✓ Standard only: specify left- or right-side cord loop.
- ✓ Specify any optional cord loop drops.
- ✓ Specify optional mounting hardware or other optional features.

Duolite Only

- ✓ On order form, list top fabric panel first and bottom fabric panel second.
- ✓ Blackout fabric is available on bottom panel only.
- ✓ The fabric type must be the same if a semi-opaque fabric is ordered for both top and bottom panels.
- ✓ All hardware will **coordinate with** the bottom panel fabric selection.

APPLICATIONS

- Fits sloped (either top or bottom sloping) window openings.
- May be operable or stationary.
- Stationary shades are usually triangles, one angle of which must be 90 degrees.
- If operable, a triangular area at the top of window opening remains covered. Bottom rail will only raise to point where shade begins to narrow.

Size Standards

See Size Standards on page AP-4

Mounting Requirements

Same as Cordlock Standard (see page AP-23)

Finished Dimensions

- Finished dimensions vary depending on the degree of the angle. Contact your Hunter Douglas fabricator for specific information.

Note

- Stationary angle specialty shapes may not fully cover the light gap at all corners.

Hardware Included

Installation brackets

Optional Features

No Charge — Specify on Order

Swivel brackets (inside mounts only)

Spacer blocks

Extension brackets

Hold-down brackets

Cord length

HOW TO CALCULATE AREA

- Use inches for calculations.
- Multiply W x H. Divide by 144.
- Multiply W x AH (angle height) x 1/2. Divide by 144.
- Add the two areas.

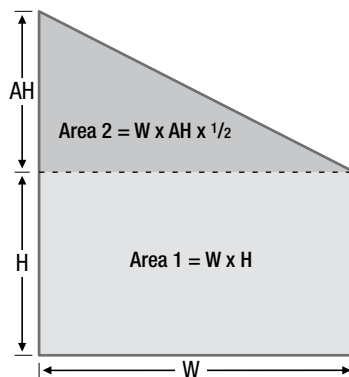

HOW TO PRICE

- **Important Note!** All base prices are predicated on Ordered Dimensions, not Finished Dimensions.
- Add angles surcharge to Cordlock Standard base price (see pages AP-6 to AP-11) using overall shade measurements.

EXCLUSIONS

- Puressence™ 3/4" semi-opaque fabric
- Blackout fabrics are not available in angle shades with a slope greater than 45 degrees
- Double honeycomb fabrics not available as Angle Bottom shades

ORDERING CHECKLIST

- ✓ Include a template with each shade ordered. See template preparation instructions in the General Information section — Measuring Guidelines.
- ✓ Specify whether the shade is operable or stationary.
- ✓ Specify optional brackets or spacer blocks, if required.
- ✓ Cordlock on angle top shades must always be at the lower end of the headrail.

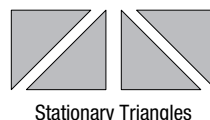
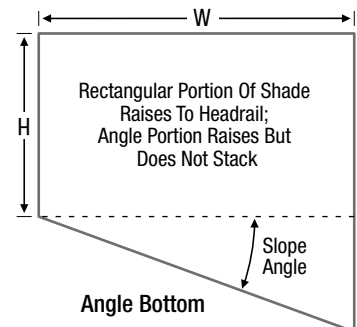
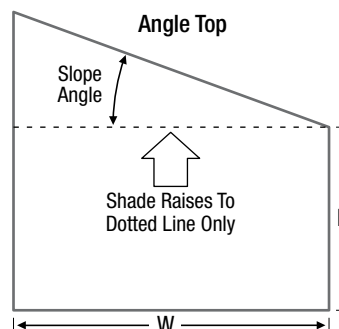
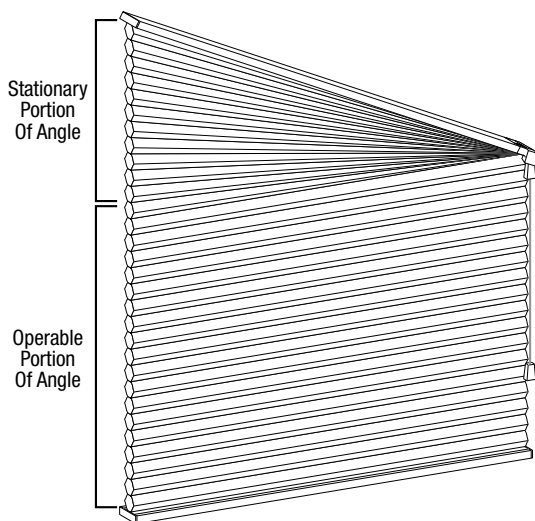

Specialty Shapes Product Specifications

APPLAUSE® HONEYCOMB SHADES

APPLICATIONS

- Fits hexagon, octagon or trapezoid shaped window openings.
- Choice of stationary or operable (from Bottom-Up or Top-Down).
- Inside-mounted octagons and hexagons open only through widest section of shade.
- Trapezoids must open toward wider rail.

Size Standards

See Size Standards on page AP-4

Mounting Requirements

Same as Cordlock Standard (see page AP-23)

Note

- With trapezoids, the maximum width reduction of the shorter rail is 9" per side.

Finished Dimensions

(All allowances are taken from ordered dimensions and may vary slightly.)

All Shapes — Inside (IB) Mount

Headrail unit	-3/16"
Fabric height	ordered height
Fabric width	-3/8"

All Shapes — Outside (OB) Mount

Rail unit	+3/16"
Shade height	ordered height
Fabric width	ordered width

Hardware Included

Installation brackets

Optional Features

No Charge — Specify on Order

Swivel brackets (inside mounts only)
Wall mount brackets
Spacer blocks
Extension brackets
Hold-down brackets
Cord length

HOW TO PRICE

- **Important Note!** All base prices are predicated on Ordered Dimensions, not Finished Dimensions.
- Add specialty shapes surcharge to Cordlock Standard base price (see pages AP-6 to AP-11) using overall shade measurements.
- Add Top-Down surcharge, if applicable.

EXCLUSION

- Purescence™ 3/4" semi-opaque fabric

ORDERING CHECKLIST

- ✓ Include a template for each shade ordered. See template preparation instructions in the General Information section — Measuring Guidelines.
- ✓ Specify left- or right-side lift cords.
- ✓ Specify whether the shade operates Bottom-Up, Top-Down or is stationary.
- ✓ Specify optional brackets or spacer blocks, if required.

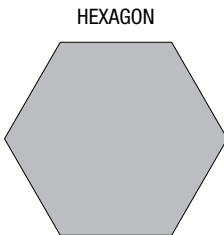

HEXAGON

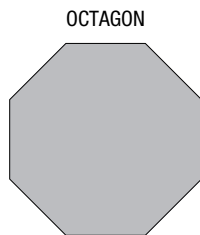

OCTAGON

Specify Whether Operation Is Bottom-Up, Top-Down Or Stationary

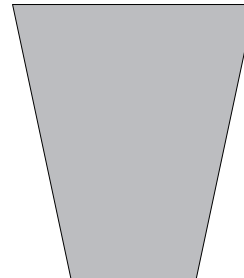
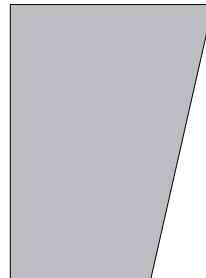

TRAPEZOIDS

Bottom-Up Operation Only

Top-Down Operation Only

APPLICATIONS

- Fits rectangular window openings.
- Standard or Top-Down operation.
- Remote control battery-powered operation is standard.
- Optional components available (see page AP-34).

Size Standards

See Size Standards on page AP-5

Mounting Requirements

³/₈" Pleat

Inside (IB) Mount/End (EB) Mount

Minimum mounting depth	¹¹ / ₁₆ "
------------------------	---------------------------------

Minimum mounting depth, flush mount	2"
-------------------------------------	----

Outside (OB) Mount

Minimum flat vertical surface	³ / ₄ "
-------------------------------	-------------------------------

³/₄" Pleat and Double Honeycomb

Inside (IB) Mount/End (EB) Mount

Minimum mounting depth	¹¹ / ₁₆ "
------------------------	---------------------------------

Minimum mounting depth, flush mount	2 ¹ / ₂ "
-------------------------------------	---------------------------------

Outside (OB) Mount

Minimum flat vertical surface	³ / ₄ "
-------------------------------	-------------------------------

Note: For headrail dimensions please refer to the General Information section — Measuring Guidelines of this Reference Guide.

Finished Dimensions

(All allowances are taken from ordered dimensions and may vary slightly.)

Inside (IB) Mount

Headrail unit	- ³ / ₁₆ "
---------------	----------------------------------

Shade height	ordered height
--------------	----------------

Fabric width	- ³ / ₈ "
--------------	---------------------------------

Outside (OB) Mount

Headrail unit	ordered width
---------------	---------------

Shade height	ordered height
--------------	----------------

Fabric width	- ³ / ₁₆ "
--------------	----------------------------------

End (EB) Mount

Headrail unit	- ¹¹ / ₁₆ "
---------------	-----------------------------------

Shade height	ordered height
--------------	----------------

Fabric width	- ⁷ / ₈ "
--------------	---------------------------------

Hardware Included

Installation brackets

Optional Features

No Charge — Specify on Order

Spacer blocks

Extension brackets

Surcharge — Specify on Order

Cut-outs — standard only (see page AP-36)

HARDWARE COLORS

- Headrail and bottom rail colors will complement the fabric selection.
- Bottom rail (and center rail) can be coordinated to the shade fabric if specified when ordering.

HOW TO PRICE

- **Important Note!** All base prices are predicated on Ordered Dimensions, not Finished Dimensions.
- Locate the suggested Cordlock Standard base price of the shade using charts A1 to A7 (see pages AP-6 to AP-12).
- Add width-based PowerRise® with Platinum™ Technology surcharge to base price.
- Add surcharge for at least one hand-held Platinum remote or wireless wall switch.
- Add surcharges for any options ordered as shown in the PowerRise with Platinum Technology Surcharges chart on page AP-22.

EXCLUSIONS

- Arches over PowerRise shades
- Marine use

ORDERING CHECKLIST

- ✓ Specify inside (IB), outside (OB) or end (EB) mount. Order extension brackets for end mount applications.
- ✓ Specify Top-Down option, if desired.
- ✓ Specify color-coordinated bottom rail (and center rail), if desired.
- ✓ Specify for outside mounts if spacer blocks are needed for added clearance.
- ✓ Specify left- or right-side infrared eye (even if ordering satellite eye).
- ✓ Specify number of Platinum remotes or wireless wall switches required.
- ✓ If ordering satellite eye, specify wire length: 20", 4', or 8'.
- ✓ If ordering satellite battery pack, specify wire length: 15", 4', or 8'.
- ✓ If ordering DC power supply, specify wire length: 12', 16' or 25'.
- ✓ Specify IR channel 2 operation for independent infrared operation of adjacent or stacked shades.
- ✓ Specify if daisy-chain cables are required to daisy-chain up to three shades (requires DC power supply).

Note: Keep in mind which side the satellite eye is positioned on each shade when determining daisy-chain length.

Cut-Out Product Specifications

APPLAUSE® HONEYCOMB SHADES

APPLICATIONS

- Cut-outs are suggested for clearance around obstructions.
- Cut-outs may be at the bottom of the shade only, on either or both sides.
- Available with the following:
 - Single panel Cordlock and EasyRise™ Standard shades
 - PowerRise® Standard shades
 - Vertiglide™ shades

Cut-Out Specifications

Cordlock, EasyRise and PowerRise Shades

Width	
Maximum	3"
Height	
Maximum	Top of cut-out must be greater than 12" from the headrail

Vertiglide Shades

Width	
Required*	1"
Height†	
Maximum	6"

*1" is the only cut-out width available for Vertiglide shades.

†Height of cut-out is measured from the floor to the top of the desired cut-out location.

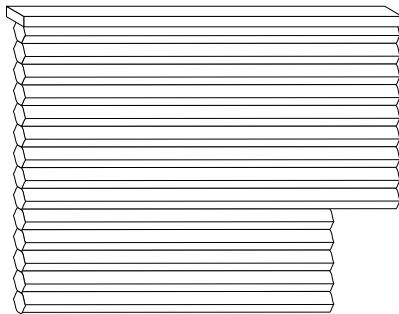

Note: Cut-outs can be on the left, right or both sides of the shade.

HOW TO PRICE

- Important Note! All base prices are predicated on Ordered Dimensions, not Finished Dimensions.
- Add surcharge per cut-out to base price charts A1 to A3 (see pages AP-6 to AP-10), or Vertiglide base price charts E1 to E4 (see pages AP-20 and AP-21).
- Add Applause® with EasyRise or PowerRise surcharge, if applicable.

EXCLUSIONS

- Puressence™ 3/4" semi-opaque fabric
- Double honeycomb fabrics
- Top-Down
- Top-Down/Bottom-Up
- Two-On-One Headrail
- Duolite™ option
- LiteRise® system
- Skyrise® system
- Simplicity™ system
- Arches
- Angles
- Specialty shapes
- Sidelights

ORDERING CHECKLIST

- ✓ Cut-outs on Vertiglide shades are available for inside flush (IB) and inside non-flush (NB) mounts only.
- ✓ Vertiglide shade height must be 60" or greater.
- ✓ Only available on single honeycomb fabrics.
- ✓ Bottom rail will also be cut out on standard shades. Side rail will be cut out on Vertiglide shades.
- ✓ Specify cut-out dimensions.
- ✓ Specify whether cut-out should be made on the right, left or on both sides of the shade.
- ✓ Only bottom side cut-outs are available.